

LASER COMPONENT
PARTS CATALOG

American
LASER ENTERPRISES, LLC. 



American Laser Enterprises

PO Box 309
Novi, MI 48376

28221 Beck Road, Unit A-4
Wixom, MI 48393

Phone: 248-449-3714
Fax: 248-449-7631
www.a-l-e.net

ALE stocks thousands of the parts you need to keep your beam delivery system maintained and operating at its peak performance. Call today and speak to our knowledgeable representatives about the advantages of partnering with American Laser Enterprises for all of your laser processing component parts needs.

Prices and product availability subject to change without notice. Call for current prices. Not responsible for photographic or typographical errors. American Laser Enterprises, LLC is not liable under any legal theory for consequential or incidental damages arising from shipping delays or expense arising from product malfunction or defect. American Laser Enterprises, LLC warrants mechanical parts against defects in material and workmanship for a period of 30 days from the original invoice ship date. During the warranty period, American Laser Enterprises, LLC, at its option, will either repair or replace mechanical parts that prove to be defective. While our optics are manufactured to the highest quality standards, American Laser Enterprises, LLC does not warrant optics due to their fragile nature. The warranty set forth is exclusive and no other warranty, whether written or oral, is expressed or implied. American Laser Enterprises, LLC specifically disclaims any implied warranties, including any implied fitness for a particular purpose. If items purchased are for the purpose of export, purchaser must obtain from the Federal Government any necessary export documentation before shipping to a foreign country. American Laser Enterprises is in no way affiliated with the companies listed in this catalog. Some parts advertised for sale are not genuine manufacturer replacement parts, but are parts made for and by American Laser Enterprises, LLC. Reference to manufacturer's machines, components and numbers are for your convenience only. We reserve the right to substitute genuine manufacturer parts in place of American Laser Enterprises, LLC parts. Corporate names and trademarks stated herein are the property of their respective companies.

Contents: Quick Reference

Section	Page
Amada ®	
Nozzles	6
Parts	9
Optics	11
Cables	11
Bystronic ®	
Nozzles	12
Parts	13
Optics	15
Cincinnati ®	
Nozzles	16
Parts	17
Cables	19
Optics	19
Mazak ®	
Nozzles	20
Parts	22
Optics	30
Cables	30
Mitsubishi ®	
Nozzles	31
Parts	32
Optics	32
Precitec ®	
Nozzles	33
Trumpf ®	
Nozzles	35
Parts	38
Optics	39
Optics	40
Cables	42

Page Numbers
Are Printer
Friendly

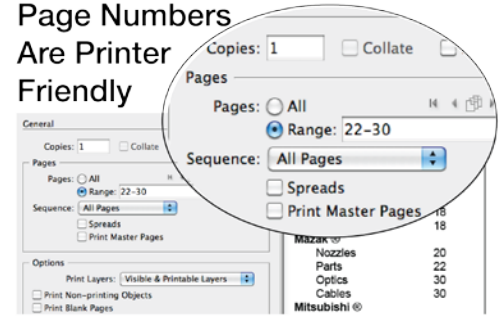

Pg. 27
Mazak
Hypergear
Torch Assembly
and Individual
Components

Optics Care and More



Pg. 41



Armordillo™
Custom Cable
Ordering Guide
Pg 44



Have **Trashed** Parts?

Don't Buy New!

Call and ask about Repair Services

Even if it looks like a hand grenade went off right under your machine, call us and ask about how much you can save with a repair made by ALE laser process experts. Feel confident you're getting the most competitive rates in the industry. ALE repair services offers the opportunity to increase your uptime and lower your replacement costs.

P: 248-449-3714

F: 248-449-7631

www.a-l-e.net



American
LASER ENTERPRISES, LLC.



28221 Beck road, Unit A-4 • Wixom, MI • 48393



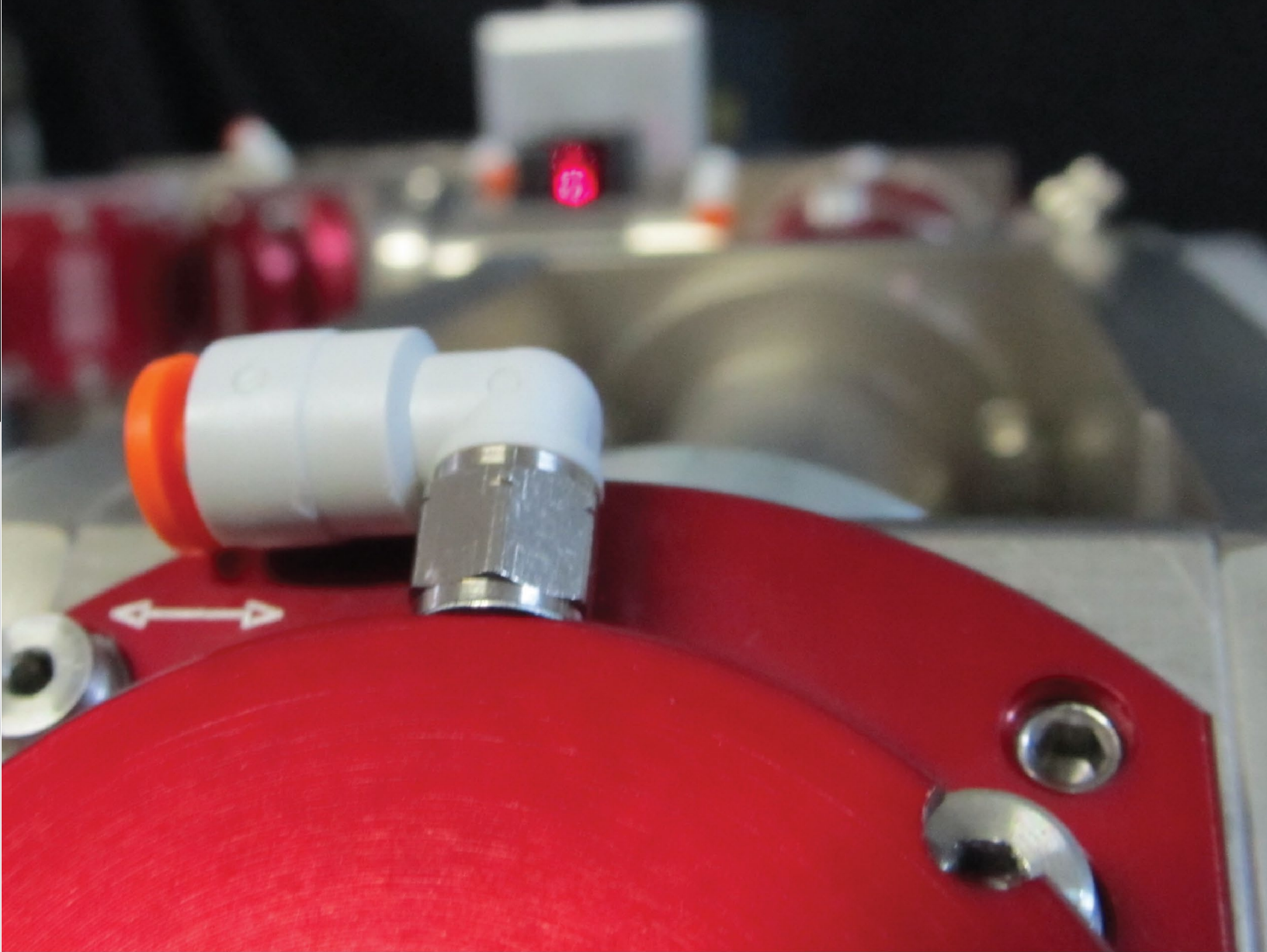

CuttingEdge Custom Laser Solutions



Let the experts at American Laser Enterprises help you design and build a solution based on your laser processing application needs. Standardize and hand select consumables and spares to maximize efficiency, and count on 100% Made in USA quality.



Nozzles Mazak®

Part	Part No.	OEM No.	Description
	100201	46603350508	Mazak Nozzle 0.8mm
	100193	46603350511	Mazak Nozzle 1.0mm
	100194	46603350512	Mazak Nozzle 1.2mm
	100076	46603350520	Mazak Nozzle 1.5mm
	100195	46603350517	Mazak Nozzle 1.7mm
	100196	46603350522	Mazak Nozzle 2.0mm
	100197	46603350525	Mazak Nozzle 2.5mm
	100198	46603350530	Mazak Nozzle 3.0mm
	100365	46603350523-08	Mazak Nozzle 0.8mm (Shower)
100471	46603350523-10	Mazak Nozzle 1.0mm (Shower)	
100077	46603350523-15	Mazak Nozzle 1.5mm (Shower)	
	100333	46603350521	Mazak Nozzle 1.0mm - Tapered
	100269	46603350520	Mazak Nozzle 1.5mm - Tapered
	100270	46603350522	Mazak Nozzle 2.0mm - Tapered
	100273	46603350522-2.5	Mazak Nozzle 2.5mm - Tapered
	100247	46683301810	Mazak Side Blow Nozzle 1.0mm
	100248	46683301950	Mazak Side Blow Nozzle 1.5mm
	100249	46683301821	Mazak Side Blow Nozzle 2.0mm
	100250	46683301960	Mazak Side Blow Nozzle 2.5mm
	100268	46683301970	Mazak Side Blow Nozzle 3.0mm
	100527	46143304470	Mazak Nozzle HG 1.2mm - CP
	100528	46143304450	Mazak Nozzle HG 1.5mm - CP
	100529	46143304460	Mazak Nozzle HG 2.0mm - CP
	100530	46143304480	Mazak Nozzle HG 2.5mm - CP
	100531	46143304490	Mazak Nozzle HG 3.0mm - CP
	100532	46143304500	Mazak Nozzle HG 3.5mm - CP
	100534	46143304510	Mazak Nozzle HG 4.0mm - CP
	100535		Mazak Double Nozzle HG 1.2mm - CP
	100536		Mazak Double Nozzle HG 1.5mm - CP
	100537		Mazak Double Nozzle HG 2.0mm - CP

CP = Chrome Plated • HD = Tapered • STD = Standard

American Laser Enterprises, LLC. is in no way affiliated with MAZAK®. The parts advertised are not genuine MAZAK® parts, but made for and by American Laser Enterprises, LLC. References to MAZAK® machines and parts are for your convenience only. Corporate names and trademarks stated herein are the property of their respective companies.

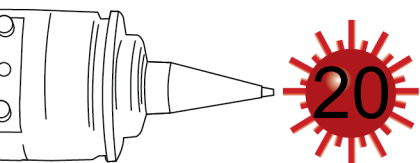





Contact Us

sales@a-l-e.net
P:248 449 3714
F:248 449 7631
www.a-l-e.net

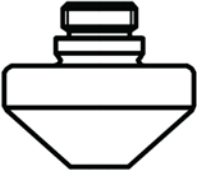

Nozzles Mazak®

Part	Part No.	OEM No.	Description
	100518 100519 100520 100521		Mazak Nozzle HG 1.0mm - Long Mazak Nozzle HG 1.2mm - Long Mazak Nozzle HG 1.5mm - Long Mazak Nozzle HG 2.0mm - Long
	100522 100523 100524 100525 100526		Mazak Nozzle HG 1.0mm Mazak Nozzle HG 1.2mm Mazak Nozzle HG 1.5mm Mazak Nozzle HG 2.0mm Mazak Nozzle HG 3.0mm
	100491 100444 100323 100328 100429 100430	46713300290 46713300280	Mazak Nozzle 3D 1.0mm Mazak Nozzle 3D 1.2mm Mazak Nozzle 3D 1.5mm Mazak Nozzle 3D 2.0mm Mazak Nozzle 3D 2.5mm Mazak Nozzle 3D 3.0mm
	100467 100423 100422 100442 100469	46713300310 46713300300	Mazak Nozzle 1.2mm 2D Mazak Nozzle 1.5mm 2D Mazak Nozzle 2.0mm 2D Mazak Nozzle 2.5mm 2D Mazak Nozzle 3.0mm 2D
	100235 100236 100237 100238 100239 100448		Mazak Nozzle ZK 1.0mm Mazak Nozzle ZK 1.2mm Mazak Nozzle ZK 1.5mm Mazak Nozzle ZK 1.8mm Mazak Nozzle ZK 2.0mm Mazak Nozzle ZK 2.5mm
	100230 100231 100232 100233 100234		Mazak Nozzle KK 1.0mm Mazak Nozzle KK 1.2mm Mazak Nozzle KK 1.5mm Mazak Nozzle KK 1.8mm Mazak Nozzle KK 2.0mm

CP = Chrome Plated • HD = Tapered • STD = Standard

American Laser Enterprises, LLC. is in no way affiliated with MAZAK®. The parts advertised are not genuine MAZAK® parts, but made for and by American Laser Enterprises, LLC. References to MAZAK® machines and parts are for your convenience only. Corporate names and trademarks stated herein are the property of their respective companies.



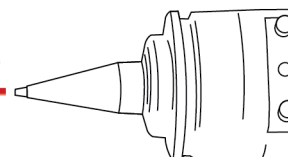

sales@a-l-e.net
P:248 449 3714
F:248 449 7631
www.a-l-e.net

Contact Us



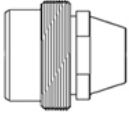
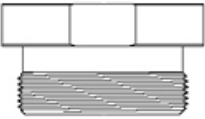
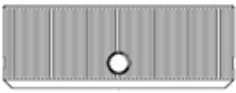
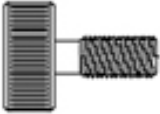

Parts Mazak®

Part	Part No.	OEM No.	Description
	050048	46683300030	Mazak Retainer Nut
	040029	46603350510	Mazak Tip Adapter - Brass
	200057	46523300080	Mazak Centering Hub
	160015	46683300930	Mazak Ring
	050047	46603300032	Mazak Bolt M5 X 0.5
	200052	36673300280	Mazak Breakaway Bar 60mm
	200071	36572301012	Mazak Breakaway Bar 61mm
	200051	36602300230	Mazak Breakaway Bar 89mm
	200470	36682300281	Mazak Stylus Arm

American Laser Enterprises, LLC. is in no way affiliated with MAZAK®. The parts advertised are not genuine MAZAK® parts, but made for and by American Laser Enterprises, LLC. References to MAZAK® machines and parts are for your convenience only. Corporate names and trademarks stated herein are the property of their respective companies.

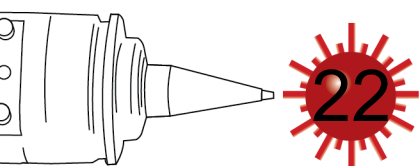







Contact Us

sales@a-l-e.net
P:248 449 3714
F:248 449 7631
www.a-l-e.net

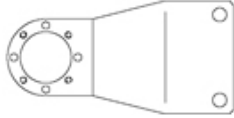

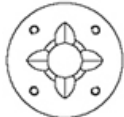
Parts Mazak®

Part	Part No.	OEM No.	Description
	200049	36602300580	Mazak Stylus Arm - Proxy Switch
	200050	36682300050	Mazak Stylus Arm
	200161	36602350020	Mazak Stylus Arm - High Version
	200156	46522300250	Mazak Stylus Arm - Pin Style
	200056	46512300520	Mazak Brass Stylus Foot - 4mm
	200058 200047 200048	46572301041 46572301041S 46572301041T	Mazak Brass Stylus Foot - 12mm Mazak Steel Stylus Foot - 12mm Mazak Teflon Stylus Foot - 12mm
	200059 200061	46572301043 46602350080	Mazak Steel Stylus Foot - 9mm Mazak Brass Stylus Foot - 9mm
	200060	46572301045 46572301043 46572350080	Mazak Teflon Stylus Foot - 9mm Mazak Steel Stylus Foot - 9mm Mazak Brass Stylus Foot - 9mm

American Laser Enterprises, LLC. is in no way affiliated with MAZAK®. The parts advertised are not genuine MAZAK® parts, but made for and by American Laser Enterprises, LLC. References to MAZAK® machines and parts are for your convenience only. Corporate names and trademarks stated herein are the property of their respective companies.





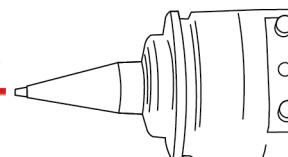

sales@a-l-e.net
P:248 449 3714
F:248 449 7631
www.a-l-e.net

Contact Us

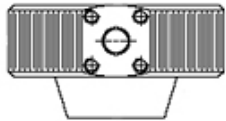

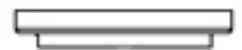
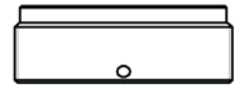

Parts Mazak®

Part	Part No.	OEM No.	Description
	200065	46683301140	Mazak Aluminum Housing
	160018	46683301160	Mazak Copper Ring
	170003	46683301150	Mazak Teflon Spacer
	200067	46683301841	Mazak Teflon Cover - Side Blow
	200072	46683301930	Mazak Teflon Cover - New Style
	160017	46683301130	Mazak Teflon Ring
	060175	4671330200	Mazak Insulating Ring - New
	160016	46683301120	Mazak Teflon Ring

American Laser Enterprises, LLC. is in no way affiliated with MAZAK®. The parts advertised are not genuine MAZAK® parts, but made for and by American Laser Enterprises, LLC. References to MAZAK® machines and parts are for your convenience only. Corporate names and trademarks stated herein are the property of their respective companies.

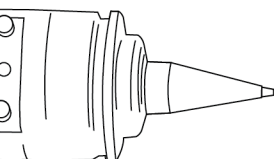







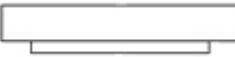

Contact Us

sales@a-l-e.net
P:248 449 3714
F:248 449 7631
www.a-l-e.net

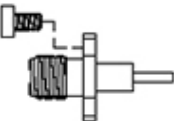
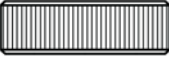
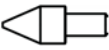
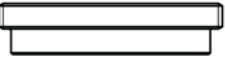

Parts Mazak®

Part	Part No.	OEM No.	Description
	200063	46683301100	Mazak Copper Bracket
	160014	46683301090	Mazak Teflon Ring
	200062	46683301070	Mazak Brass Base
	160012	46683301080	Mazak Teflon Ring
	200055	46683301110	Mazak Top Bracket
	200073	46683301851	Mazak Teflon Connector Cover - SMA
	200066 050049 050050	46683301170 46683300000 46683301180	Mazak Connector - SMA Mazak Screw M2.5 X 4 Mazak Set Screw
	050813	46583301720	Mazak Retainer Nut
	050814	46600030013	Mazak Table Pin
	090106		Mazak Mount for Lens 2.0"
	0400044	46522300242	Mazak Stylus Pin

American Laser Enterprises, LLC. is in no way affiliated with MAZAK®. The parts advertised are not genuine MAZAK® parts, but made for and by American Laser Enterprises, LLC. References to MAZAK® machines and parts are for your convenience only. Corporate names and trademarks stated herein are the property of their respective companies.





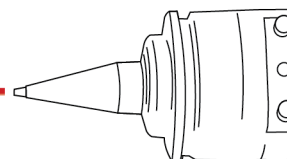

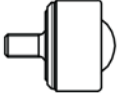
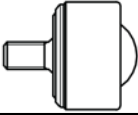

sales@a-l-e.net
P:248 449 3714
F:248 449 7631
www.a-l-e.net

Contact Us



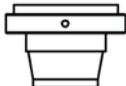
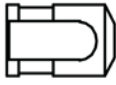

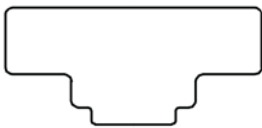
Parts Mazak®

Part	Part No.	OEM No.	Description
	200069	Z21KV000580	Mazak Table Roller
	200471	Z21ZZ001160	Mazak Table Roller - Big
	200070	46575100321	Mazak Bearing Block - 42mm
	200123	46705100050	Mazak Bearing Block - 66mm
	200473		Mazak Bearing Block - 61mm
	200064	46683300850	Mazak Nozzle Body
	200472	46683300720	Mazak Nozzle Body - Special
	200147	46683301860	Mazak Teflon Cable Connector Cover
	200148	46683301870	Mazak Teflon Cover Clip
	040030	46683301230	Mazak Plate
	130102	46713300321	Mazak Vespel Nut - Space Gear Note: Aluminum Available

American Laser Enterprises, LLC. is in no way affiliated with MAZAK®. The parts advertised are not genuine MAZAK® parts, but made for and by American Laser Enterprises, LLC. References to MAZAK® machines and parts are for your convenience only. Corporate names and trademarks stated herein are the property of their respective companies.

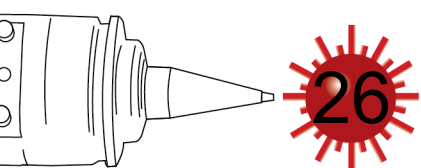

Contact Us

sales@a-l-e.net
P:248 449 3714
F:248 449 7631
www.a-l-e.net

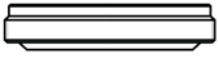

Parts Mazak®

Part	Part No.	OEM No.	Description
	060015 060040		Mazak Plastic Insulating Ring - Original Mazak Plastic Insulating Ring - Nylon

Assembly Mazak®

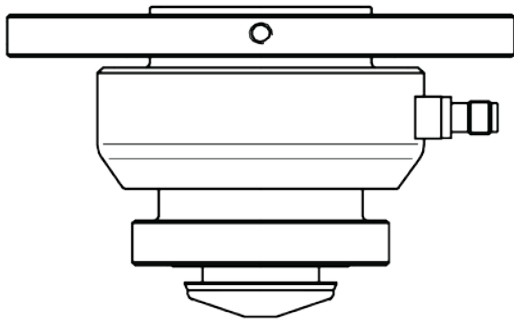

Part No.	140022
OEM / Reference No.	
Mazak® HYPERGEAR Torch with Ceramic	

Don't need the whole assembly? Select from our comprehensive inventory of quality spare parts. With same day shipping and the most competitive prices in the industry, we can keep your MAZAK® beam deliver system producing.

Parts Mazak®

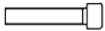



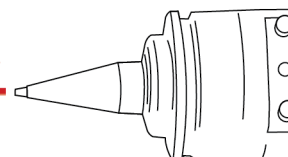



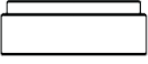

Part	Part No.	OEM No.	Description
	050798	A06CB040200	Mazak HG Set Screw for Head (4)

American Laser Enterprises, LLC. is in no way affiliated with MAZAK®. The parts advertised are not genuine MAZAK® parts, but made for and by American Laser Enterprises, LLC. References to MAZAK® machines and parts are for your convenience only. Corporate names and trademarks stated herein are the property of their respective companies.

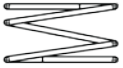

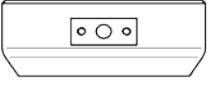

Parts Mazak®

Part	Part No.	OEM No.	Description
	100488	36143304420	Mazak HG Nozzle Adapter HTX
	100489	36143304400	Mazak HG Coupler
	130131	46143304430	Mazak HG Spring Retainer
	050795	46143300230	Mazak HG Ball Kit (6)
	130124	46143308000	Mazak HG Coupler Ring
	050796	46143300220	Mazak HG Spring
	130129	36143303242	Mazak HG Body
	130127	36143307980	Mazak HG Aluminum Body
	050797	46603300030	Mazak HG Screw for Connector (2)
	170033	46143308170	Mazak HG Aluminum Spacer for Connector
	070016	46143308190	Mazak HG Connector

American Laser Enterprises, LLC. is in no way affiliated with MAZAK®. The parts advertised are not genuine MAZAK® parts, but made for and by American Laser Enterprises, LLC. References to MAZAK® machines and parts are for your convenience only. Corporate names and trademarks stated herein are the property of their respective companies.

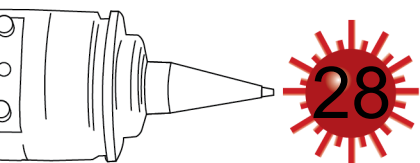











Contact Us

sales@a-l-e.net
P:248 449 3714
F:248 449 7631
www.a-l-e.net



Parts Mazak®

Part	Part No.	OEM No.	Description
	060172	46143300240	Mazak HG 40X5 Insulator
	130128	46143304250	Mazak HG Retainer Nut with Amplifier Hole 2.0
	130126	46143307420	Mazak HG Retainer Nut with Amplifier Hole 1.4
	050799	46143301180	Mazak HG Screw
	060171	46143304440	Mazak HG 40X6 Insulator
	130132	46143300290	Mazak HG Retainer Nut
	060173	46143300260	Mazak HG 40X4 Insulator
	060174	46143300270	Mazak HG 38X5.5 Insulator
	1310133	46143300280	Mazak HG Retainer Nut with Cone
	130122	46143300320	Mazak HG Brass Ring
	130125	36143300332	Mazak HG Aluminum Ring

American Laser Enterprises, LLC. is in no way affiliated with MAZAK®. The parts advertised are not genuine MAZAK® parts, but made for and by American Laser Enterprises, LLC. References to MAZAK® machines and parts are for your convenience only. Corporate names and trademarks stated herein are the property of their respective companies.

sales@a-l-e.net
P:248 449 3714
F:248 449 7631
www.a-l-e.net

Contact Us

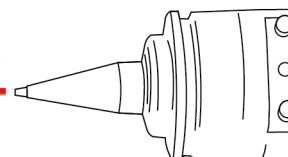

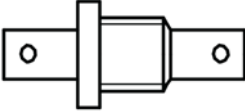

Parts Mazak®

Part	Part No.	OEM No.	Description
	040032	D60RA012460	Mazak Sensor Cable Adapter

Standard Focusing Lenses and Optics

Optics Mazak

Part No.	OEM No.	Description
110116	Z50ZZ000400	Lens D1.5 - f5.0 - .300ET
110123	Z50ZZ005160A	Lens D2.0 - f5.0 - .380ET
110106	Z50ZZ005200	Lens D2.0 - f7.5 - .380ET

Sensor Cable Mazak

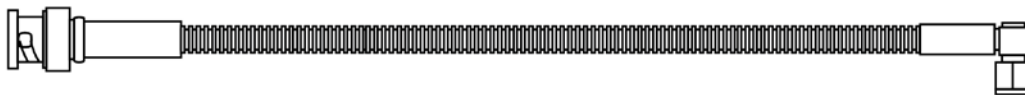

Part No.	200068
OEM / Reference No.	46683301980
Mazak Sensor Cable 11 in.	

Part No.	070074
OEM / Reference No.	46683301330
Mazak Long Sensor Cable 12 in.	

Part No.	200068A
OEM / Reference No.	46683301980
Armordillo™ Cable for Mazak Sensor Cable	
Long life. Thermally Resistant. Shielded. Pg 49.	

Part No.	070074A
OEM / Reference No.	46683301330
Armordillo™ Cable for Mazak Long Sensor Cable	
Long life. Thermally Resistant. Shielded. Pg 49.	

American Laser Enterprises, LLC. is in no way affiliated with MAZAK®. The parts advertised are not genuine MAZAK® parts, but made for and by American Laser Enterprises, LLC. References to MAZAK® machines and parts are for your convenience only. Corporate names and trademarks stated herein are the property of their respective companies.

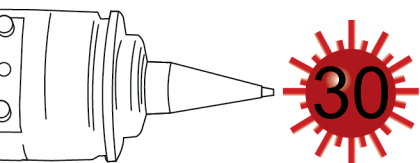

Contact Us

sales@a-l-e.net
P:248 449 3714
F:248 449 7631
www.a-l-e.net



Optics

Part No.	OEM No.	Description
Amada		
110115	81140303	Lens D1.1 - f5.0 - .235ET - Unmounted
110116	81140305	Lens D1.5 - f5.0 - .300ET - Unmounted
110117	81140306	Lens D1.5 - f5.0 - .300ET - Mounted
110125	81140307	Lens D2.0 - f5.0 - .380ET - Unmounted
110186	81140400	Lens D1.5 - f7.5 - .300ET - Mounted
110127	81140186	Lens D2.0 - f7.5 - .300ET - Mounted
Bystronic		
110111	4-00186	Lens D1.5 - f5.0 - .236ET - Meniscus
110112	4-00187	Lens D1.5 - f7.5 - .236ET - Meniscus
110113	4-05094	Lens D1.5 - f5.0 - .350ET - Meniscus
110114	4-05095	Lens D1.5 - f7.5 - .350ET - Meniscus
Cincinnati		
110092	908085	Lens D1.5 - WD5.13 - .280ET
110096	909484	Lens D1.5 - WD7.63 - .300ET
Mazak		
110116	Z50ZZ000400	Lens D1.5 - f5.0 - .300ET
110123	Z50ZZ005160A	Lens D2.0 - f5.0 - .380ET
110106	Z50ZZ005200	Lens D2.0 - f7.5 - .380 ET
Mitsubishi		
110144	W500	Lens D1.5 - f5.0 - .300ET
110169	W505	Lens D2.0 - f5.0 - .310ET
110122	W510	Lens D2.0 - f7.5 - .310ET
Trumpf		
110109	088114	Lens D1.5 - f5.0 - .291ET - Meniscus
110110	097517	Lens D1.5 - f7.5 - .291ET - Meniscus

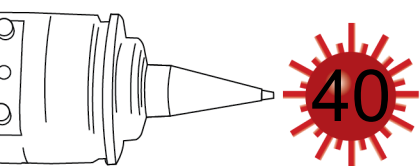

Contact Us

sales@a-l-e.net
P:248 449 3714
F:248 449 7631
www.a-l-e.net



Standard Focusing Lenses and Optics

Standard Optics Care Kit

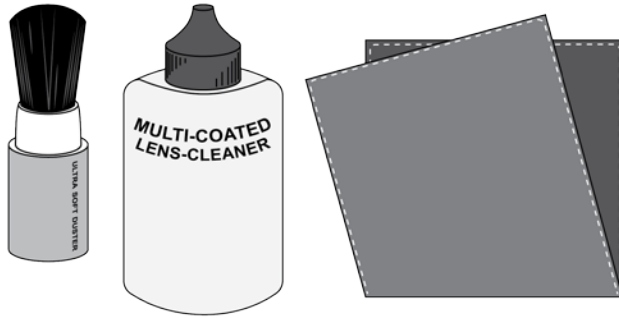

Part No.	210024
OEM / Reference No.	N/A
Optics Care Kit	

Part No.	210011
OEM / Reference No.	N/A
Premium Grade Optics Tissue (25)	

Kit Includes

- 1. Multi-Coated Lens Cleaner 1 fl. oz.
- 1. Ultra-soft duster
- 1. Lens Cleaning Soft Cloth
- 3. Premium Grade Optical Tissue (25)
- 1. Care Kit carrying case



CABLES
Custom Shielded
and OEM Replacement

Sensor Cable Amada



Part No.	070199
OEM / Reference No.	71341630
Amada Sensor Cable 12 in.	

Sensor Cable Amada



Part No.	070200
OEM / Reference No.	71369851
Amada Sensor Cable 8 in.	

Part No.	070201
OEM / Reference No.	71341901
Amada Sensor Cable 12 in.	

Sensor Cable Cincinnati



Part No.	070057
OEM / Reference No.	N/A
Cincinnati Tip Transformer Wire 6.0 in.	

have
you found that not all
cables are created equal?



ALE is proud to announce ArmorDillo™ Sensor Cables. We engineered this line of 100% American-made, outperforming cables to precise standards, so they can keep up with your equipment and your team.

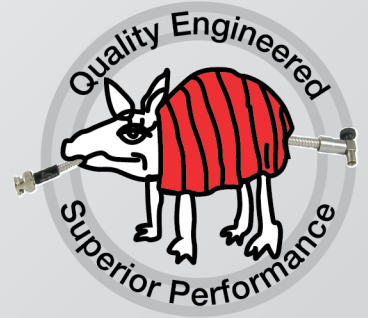

Armordillo™ cables feature:

- Additional Thermal Insulation**, which prevents burn out at the sensor nozzle connector
- Reinforced Connector Collars** to eliminate break points
- Stainless Steel Armor Sheathing** to protect against molten metal
- Custom Laser Engraving** with your logo, part number, or phone number available at no additional cost.

BNC, MCX, SMA, LTX and other specialty connectors
Available for most major laser system height sensors including Amada®, Cincinnati®, Mazak®, Mitsubishi®, Precitec®, and Trumpf®
Not limited to laser cables. If you need a cable call for the cables that ourperform.

American Laser Enterprises, LLC
28221 Beck Road, Suite A-4
Wixom, MI 48393

Phone: 248 449 3714
Fax: 248 449 7631
info@a-l-e.net

www.a-l-e.net

We Have.



Phone: 248 449 3714 Web: www.a-l-e.net
 Fax: 248 449 7631 E-mail: info@a-l-e.net



ARMORDILLO™

STRONGER.

LONGER LASTING.

ARMORED CABLES.

Armordillo™ Cable Ordering Guide

Because of the confusion over sensor cable numbers, American Laser Enterprises has developed a selection guide to help you obtain the cables you need at the most competitive rates in the industry. **Please complete the form below and fax or E-mail your request to:**

American Laser Enterprises
 Fax: (248) 449 7631
 E-mail: info@a-l-e.net

Your Information	
_____ Company	
_____ Name	
_____ Address	
_____ City/State/Zip	
_____ Phone	_____ Fax
_____ E-mail	
<input type="checkbox"/> I do not want to receive special offers and communications from ALE. ALE will not share your information.	

Build your own custom cable

1. Choose connectors. Write letter listed under desired connector in box.
2. Indicated length, units and options.
3. E-mail or Fax as listed above.

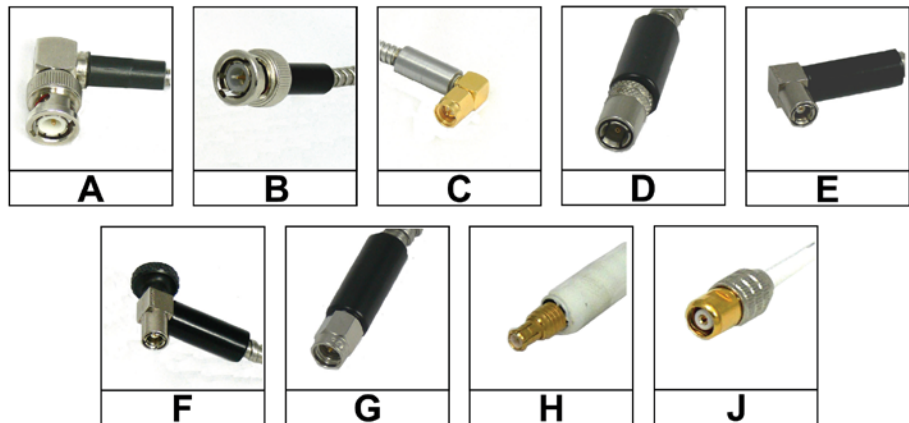

Used On:
<input type="checkbox"/> Amada
<input type="checkbox"/> Mazak
<input type="checkbox"/> Precitec
<input type="checkbox"/> _____ Other

_____ 1st Connector	_____ Length (Overall)	_____ 2nd Connector
Have an OEM No.? _____ It may hasten manufacturing time.	Units <input type="checkbox"/> English <input type="checkbox"/> Metric	Option <input type="checkbox"/> No Armor



Sensor Cable Cincinnati

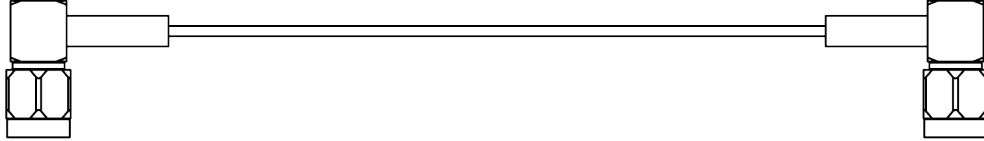

Part No.	070051
OEM / Reference No.	909654 / 922686
Cincinnati Tip Transformer Wire 4.5 in.	

Sensor Cable Mazak



Part No.	200068
OEM / Reference No.	46683301980
Mazak Sensor Cable 11 in.	

Part No.	070074
OEM / Reference No.	46683301330
Mazak Long Sensor Cable 12 in.	

