

LASER COMPONENT  
PARTS CATALOG

  
**American**  
LASER ENTERPRISES, LLC. 



**American Laser Enterprises**

PO Box 309  
Novi, MI 48376

28221 Beck Road, Unit A-4  
Wixom, MI 48393

Phone: 248-449-3714  
Fax: 248-449-7631  
**[www.a-l-e.net](http://www.a-l-e.net)**

**ALE stocks thousands of the parts you need to keep your beam delivery system maintained and operating at its peak performance. Call today and speak to our knowledgeable representatives about the advantages of partnering with American Laser Enterprises for all of your laser processing component parts needs.**

Prices and product availability subject to change without notice. Call for current prices. Not responsible for photographic or typographical errors. American Laser Enterprises, LLC is not liable under any legal theory for consequential or incidental damages arising from shipping delays or expense arising from product malfunction or defect. American Laser Enterprises, LLC warrants mechanical parts against defects in material and workmanship for a period of 30 days from the original invoice ship date. During the warranty period, American Laser Enterprises, LLC, at its option, will either repair or replace mechanical parts that prove to be defective. While our optics are manufactured to the highest quality standards, American Laser Enterprises, LLC does not warrant optics due to their fragile nature. The warranty set forth is exclusive and no other warranty, whether written or oral, is expressed or implied. American Laser Enterprises, LLC specifically disclaims any implied warranties, including any implied fitness for a particular purpose. If items purchased are for the purpose of export, purchaser must obtain from the Federal Government any necessary export documentation before shipping to a foreign country. American Laser Enterprises is in no way affiliated with the companies listed in this catalog. Some parts advertised for sale are not genuine manufacturer replacement parts, but are parts made for and by American Laser Enterprises, LLC. Reference to manufacturer's machines, components and numbers are for your convenience only. We reserve the right to substitute genuine manufacturer parts in place of American Laser Enterprises, LLC parts. Corporate names and trademarks stated herein are the property of their respective companies.



## Contents: Quick Reference

Section	Page
<b>Amada ®</b>	
Nozzles	6
Parts	9
Optics	11
Cables	11
<b>Bystronic ®</b>	
Nozzles	12
Parts	13
Optics	15
<b>Cincinnati ®</b>	
Nozzles	16
Parts	17
Cables	19
Optics	19
<b>Mazak ®</b>	
Nozzles	20
Parts	22
Optics	30
Cables	30
<b>Mitsubishi ®</b>	
Nozzles	31
Parts	32
Optics	32
<b>Precitec ®</b>	
Nozzles	33
<b>Trumpf ®</b>	
Nozzles	35
Parts	38
Optics	39
<b>Optics</b>	40
<b>Cables</b>	42

Page Numbers  
Are Printer  
Friendly

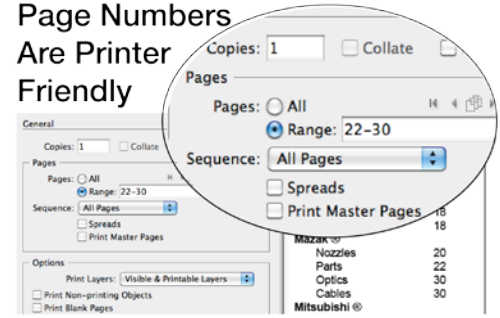

**Pg. 27**  
**Mazak**  
**Hypergear**  
Torch Assembly  
and Individual  
Components

Optics Care and More



**Pg. 41**



**Armordillo™**  
Custom Cable  
Ordering Guide  
**Pg 44**



# Have **Trashed** Parts?

## Don't Buy New!

### Call and ask about Repair Services

Even if it looks like a hand grenade went off right under your machine, call us and ask about how much you can save with a repair made by ALE laser process experts. Feel confident you're getting the most competitive rates in the industry. ALE repair services offers the opportunity to increase your uptime and lower your replacement costs.

**P: 248-449-3714**

**F: 248-449-7631**

**[www.a-l-e.net](http://www.a-l-e.net)**



**American**  
**LASER ENTERPRISES, LLC.**



28221 Beck road, Unit A-4 • Wixom, MI • 48393





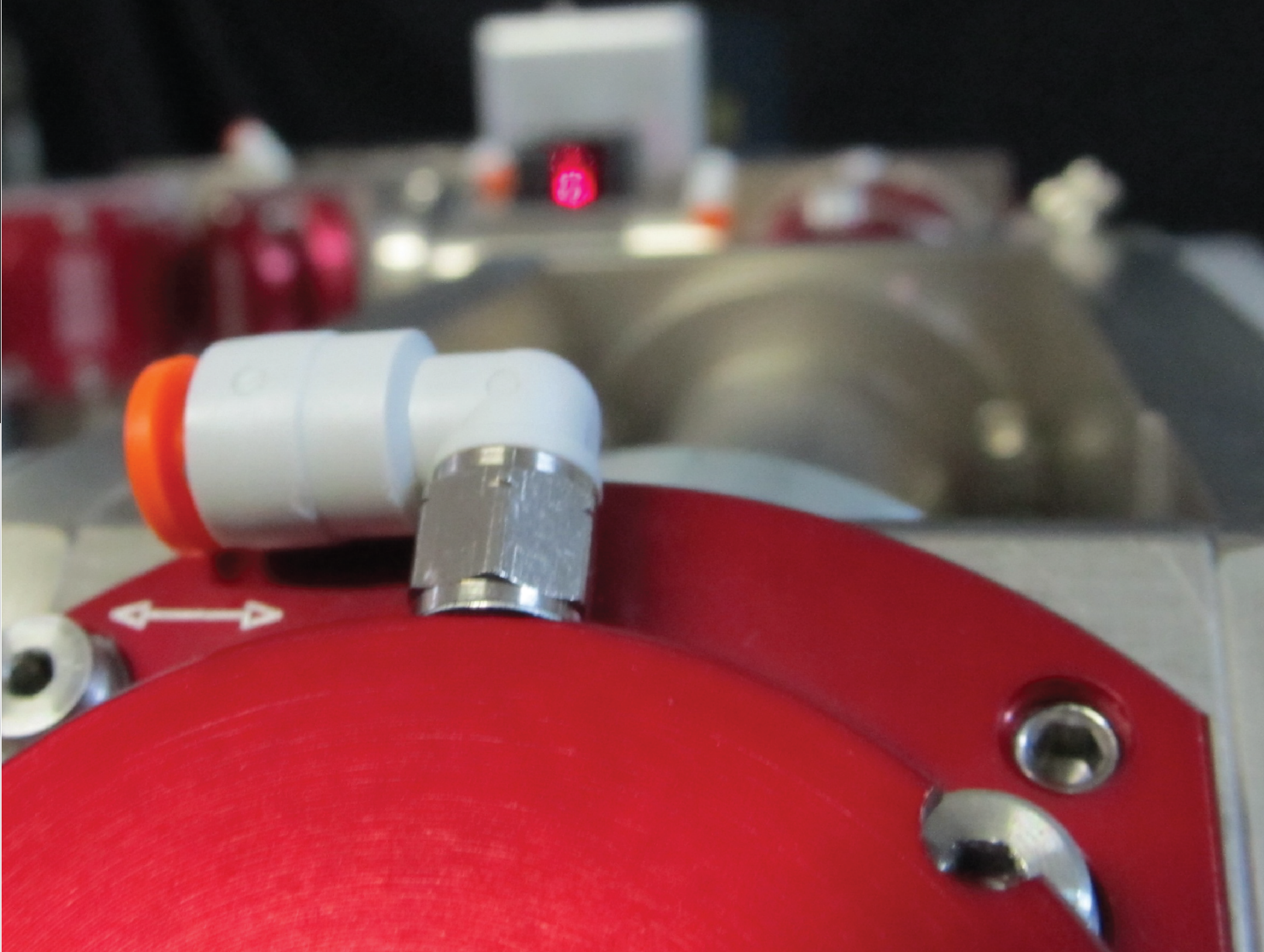

# Cutting Edge Custom Laser Solutions



Let the experts at American Laser Enterprises help you design and build a solution based on your laser processing application needs. Standardize and hand select consumables and spares to maximize efficiency, and count on 100% Made in USA quality.

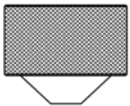
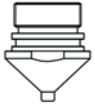

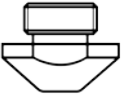
## Nozzles Amada®

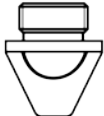
Part	Part No.	OEM No.	Description
	100017	71101905 / 841143B	Amada Outer Nozzle
	100329 100171 100172	71101901-12 71101901-15 71101902-20	Amada Fine Tip Nozzle 1.25mm - CP Amada Fine Tip Nozzle 1.5mm - CP Amada Fine Tip Nozzle 2.0mm - CP
	100182 100183 100184 100185	650689212 650689215 650689218 650689220	Amada Nozzle 1.2mm - CP Amada Nozzle 1.5mm - CP Amada Nozzle 1.7mm - CP Amada Nozzle 2.0mm - CP
	100209 100210 100211 100212	71366090-15 71366090-20 71341682-25 71366090-30	Amada WACS Single Nozzle 1.5mm - CP Amada WACS Single Nozzle 2.0mm - CP Amada WACS Single Nozzle 2.5mm - CP Amada WACS Single Nozzle 3.0mm - CP
	100190 100191 100170 100192	6209400613 6209400615 6209400620 6209400630	Amada Nozzle Cap 1.3mm - CP Amada Nozzle Cap 1.5mm - CP Amada Nozzle Cap 2.0mm - CP Amada Nozzle Cap 3.0mm - CP
	100506 100507	71712335 71712336	Amada Double Nozzle 2.5mm - CP (With Holes) Amada Double Nozzle 4.0mm - CP (With Holes)
	100186 100187 100166 100165	1664545U-10 1664545U-15 1664545U-20 1664544U-30	Amada H595 Nozzle 1.0mm - CP Amada H595 Nozzle 1.5mm - CP Amada H595 Nozzle 2.0mm - CP Amada H595 Nozzle 3.0mm - CP
	100393 100457 100394 100395	71369812/71461028 1572362-14 71369815/71501057 71369816/71501058	Amada Single Mushroom Nozzle 1.2mm - CP Amada Single Mushroom Nozzle 1.4mm - CP Amada Single Mushroom Nozzle 2.0mm - CP Amada Single Mushroom Nozzle 3.0mm - CP

CP = Chrome Plated • HD = Tapered • STD = Standard

American Laser Enterprises, LLC. is in no way affiliated with AMADA®. The parts advertised are not genuine AMADA® parts, but made for and by American Laser Enterprises, LLC. References to AMADA® machines and parts are for your convenience only. Corporate names and trademarks stated herein are the property of their respective companies.

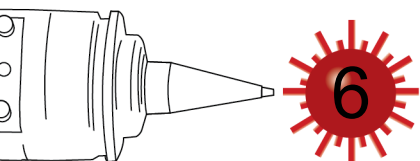







Contact Us

sales@a-l-e.net  
P:248 449 3714  
F:248 449 7631  
www.a-l-e.net

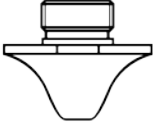

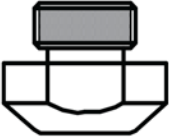

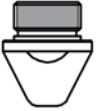
## Nozzles Amada®

Part	Part No.	OEM No.	Description
	100351 100396	71369813/71518550 71369817/71501060	Amada Double Mushroom Nozzle 1.4mm - CP Amada Double Mushroom Nozzle 4.0mm - CP
	100511 100512	62094001/71102001 62094002/71102005	Amada Large Nozzle 2.0 - CP Amada Large Nozzle 3.0 - CP
	100513	74718816	Amada Wide Nozzle 2.0mm - CP
	100419 100420	71102006 71341515-30	Amada Nozzle 2.0mm - CP Amada Nozzle 3.0mm - CP
	200474		Amada Workholder 20mm
	100541 100542	71341770	Amada Nozzle 2.0mm - CP Amada Nozzle 3.0mm - CP
	100538		Amada Nozzle 3.0 - CP Short
	100539 100540		Amada Nozzle 2.0mm - Large Flange Amada Nozzle 3.0mm - Large Flange

CP = Chrome Plated • HD = Tapered • STD = Standard

American Laser Enterprises, LLC. is in no way affiliated with AMADA®. The parts advertised are not genuine AMADA® parts, but made for and by American Laser Enterprises, LLC. References to AMADA® machines and parts are for your convenience only. Corporate names and trademarks stated herein are the property of their respective companies.

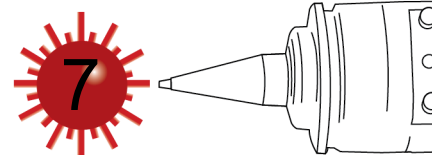

sales@a-l-e.net  
P:248 449 3714  
F:248 449 7631  
www.a-l-e.net

Contact Us



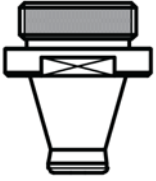
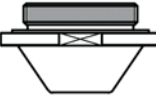
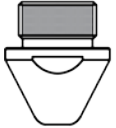
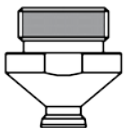

## Nozzles Amada®

Part	Part No.	OEM No.	Description
	100543	71398802	Amada Nozzle HP-X 1.4mm - CP
	100544	7134162-14	Amada Nozzle Outer HP-X CP
	100458 100277 100278 100324 100325	7134162-14 7134162-15 7134162-20 7134162-25 7134162-30	Amada HS95 Nozzle 1.4mm Double - CP Amada HS95 Nozzle 1.5mm Double - CP Amada HS95 Nozzle 2.0mm Double - CP Amada HS95 Nozzle 2.5mm Double - CP Amada HS95 Nozzle 3.0mm Double - CP
	100433 100210 100211 100350	71369810 71341682-20 71341682-25 71369806	Amada WACS Double Nozzle 1.4mm - CP Amada WACS Double Nozzle 2.0mm - CP Amada WACS Double Nozzle 2.5mm - CP Amada WACS Double Nozzle 3.8mm - CP
	100500 100501	71502039 71502040	Amada WACS Double Nozzle 2.5mm - CP Amada WACS Double Nozzle 4.0mm - CP
	100502 100503 100504 100505		Amada WACS Double Nozzle 1.4mm - CP Amada WACS Double Nozzle 1.7mm - CP Amada WACS Double Nozzle 2.0mm - CP Amada WACS Double Nozzle 5.0mm - CP

CP = Chrome Plated • HD = Tapered • STD = Standard

American Laser Enterprises, LLC. is in no way affiliated with AMADA®. The parts advertised are not genuine AMADA® parts, but made for and by American Laser Enterprises, LLC. References to AMADA® machines and parts are for your convenience only. Corporate names and trademarks stated herein are the property of their respective companies.

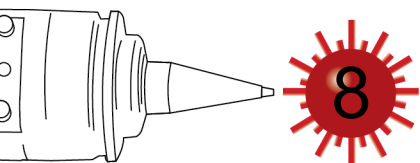





Contact Us

sales@a-l-e.net  
P:248 449 3714  
F:248 449 7631  
www.a-l-e.net



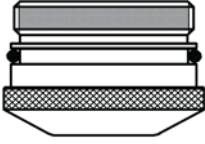

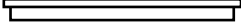
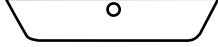
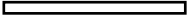
## Parts Amada®

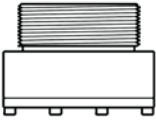
Part	Part No.	OEM No.	Description
	100018	71366452 71341684	Amada Nozzle Outer - CP
	060177	71502026	Amada WACS Nozzle Insulator 30x10 - Teflon
	200460	71502036	Amada HP-X WACS Nozzle Adaptor
	160003	71366437	Amada WACS Guard Ring
	050016	71366438	Amada WACS Guard Nut
	060002 060168 060181	71341614/71369819 71341614 71341614	Amada Insulating Disc 21mm - VESPEL Amada Insulating Disc 21mm - Teflon Amada Insulating Disc 21mm - Ceramic
	060178		Amada Insulating Disc 21mm - Rigid
	090101	MTA-15	Amada Lens Assembly D1.5

American Laser Enterprises, LLC. is in no way affiliated with AMADA®. The parts advertised are not genuine AMADA® parts, but made for and by American Laser Enterprises, LLC. References to AMADA® machines and parts are for your convenience only. Corporate names and trademarks stated herein are the property of their respective companies.



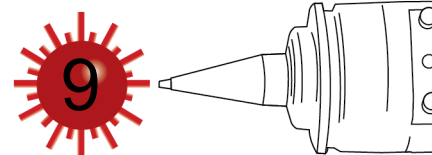

sales@a-l-e.net  
P:248 449 3714  
F:248 449 7631  
www.a-l-e.net

Contact Us



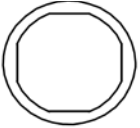
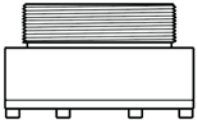
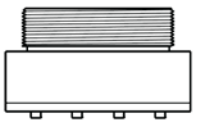
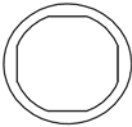

Parts Amada®

Part	Part No.	OEM No.	Description
	160106	71360261	Amada Teflon Gasket For Lens Assembly D1.5
	090102	MTA-20	Amada Lens Assembly D2.0
	090103	71362733	Amada Lens Assembly D2.0 <b>Note:</b> Fits D1.5
	160107	71361393	Amada Teflon Gasket For Lens Assembly D2.0
	090104 090105		Amada Lens Assembly f5.0 FO NT Amada Lens Assembly f7.5 FO NT
	160108	71501071	Amada Lens Gasket - FO NT
	040021		Amada Tip Adapter

American Laser Enterprises, LLC. is in no way affiliated with AMADA®. The parts advertised are not genuine AMADA® parts, but made for and by American Laser Enterprises, LLC. References to AMADA® machines and parts are for your convenience only. Corporate names and trademarks stated herein are the property of their respective companies.

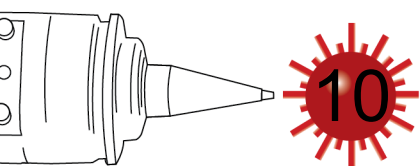

Contact Us

sales@a-l-e.net  
P:248 449 3714  
F:248 449 7631  
www.a-l-e.net





## Standard Focusing Lenses and Optics



### Optics Amada

Part No.	OEM No.	Description
110115	81140303	Lens D1.1 - f5.0 - .235ET - Unmounted
110116	81140305	Lens D1.5 - f5.0 - .300ET - Unmounted
110117	81140306	Lens D1.5 - f5.0 - Mounted
110125	81140307	Lens D2.0 - f5.0 - .380ET - Unmounted
110186	81140400	Lens D1.5 - f7.5 - Mounted
110127	81140186	Lens D2.0 - f7.5 - Mounted

### Sensor Cable Amada



Part No.	070199
OEM / Reference No.	71341630
<b>Amada Sensor Cable 12 in.</b>	

Part No.	070199A
OEM / Reference No.	71341630
<b>Armordillo™ Cable for Amada 12 in.</b>	
Long life. Thermally Resistant. Shielded. Pg 49.	

### Sensor Cable Amada



Part No.	070200
OEM / Reference No.	71369851
<b>Amada Sensor Cable 8 in.</b>	

Part No.	070201
OEM / Reference No.	71341901
<b>Amada Sensor Cable 12 in.</b>	

Part No.	070200A
OEM / Reference No.	71369851
<b>Armordillo™ Cable for Amada 8 in.</b>	
Long life. Thermally Resistant. Shielded. Pg 49.	



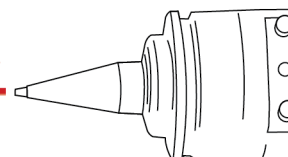

Part No.	070201A
OEM / Reference No.	71341901
<b>Armordillo™ Cable for Amada 12 in.</b>	
Long life. Thermally Resistant. Shielded. Pg 49.	

American Laser Enterprises, LLC. is in no way affiliated with AMADA®. The parts advertised are not genuine AMADA® parts, but made for and by American Laser Enterprises, LLC. References to AMADA® machines and parts are for your convenience only. Corporate names and trademarks stated herein are the property of their respective companies.



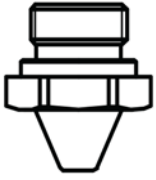
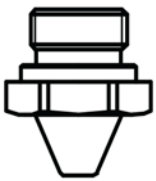

## Nozzles Bystronic®

Part	Part No.	OEM No.	Description
	100154	3-04271	Bystronic Nozzle 0.8mm
	100137	3-01894	Bystronic Nozzle 1.0mm
	100138	3-01895	Bystronic Nozzle 1.2mm
	100139	3-01896	Bystronic Nozzle 1.5mm
	100140	3-01897	Bystronic Nozzle 1.7mm
	100141	3-01898	Bystronic Nozzle 2.0mm
	100155	3-04272	Bystronic Nozzle 2.5mm
	100158	3-04275	Bystronic Nozzle 0.8mm H08
	100078	3-01899	Bystronic Nozzle 1.0mm H10
	100142	3-01900	Bystronic Nozzle 1.2mm H12
	100143	3-01901	Bystronic Nozzle 1.5mm H15
	100144	3-01902	Bystronic Nozzle 1.7mm H17
	100145	3-01903	Bystronic Nozzle 2.0mm H20
	100159	3-04276	Bystronic Nozzle 2.5mm H25
	100146	3-01905	Bystronic Nozzle 1.0mm K10
	100074	3-01906	Bystronic Nozzle 1.2mm K12
	100147	3-01907	Bystronic Nozzle 1.5mm K15
	100148	3-01908	Bystronic Nozzle 1.7mm K17
	100200	3-01909	Bystronic Nozzle 2.0mm K20
	100411	3-16058	Bystronic Double Nozzle 1.0mm NK10 - 15
	100412	3-16059	Bystronic Double Nozzle 1.2mm NK12 - 15
	100413	3-16060	Bystronic Double Nozzle 1.5mm NK15 - 15
	100414	3-14317	Bystronic Double Nozzle 1.7mm NK17 - 15
	100415	3-14318	Bystronic Double Nozzle 2.0mm NK20 - 15
	100416	3-14319	Bystronic Double Nozzle 2.5mm NK25 - 15
	100485	3-16256	Bystronic Double Nozzle 2.5mm NK25 - 20
	100486	3-16061	Bystronic Double Nozzle 3.0mm NK30 - 17
	100487	3-16257	Bystronic Double Nozzle 3.0mm NK30 - 20
	100078	3-01899	Bystronic Nozzle 1.0mm H10
	100143	3-01901	Bystronic Nozzle 1.5mm H15
	100145	3-01903	Bystronic Nozzle 2.0mm H20

CP = Chrome Plated • HD = Tapered • STD = Standard

American Laser Enterprises, LLC. is in no way affiliated with BYSTRONIC®. The parts advertised are not genuine BYSTRONIC® parts, but made for and by American Laser Enterprises, LLC. References to BYSTRONIC® machines and parts are for your convenience only. Corporate names and trademarks stated herein are the property of their respective companies.

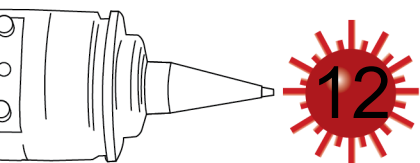

Contact Us

sales@a-l-e.net  
P:248 449 3714  
F:248 449 7631  
www.a-l-e.net



## Nozzles Bystronic®

Part	Part No.		OEM No.	Description
	Standard	Chrome Plated		
	100160		3-04277	Bystronic Nozzle 0.8mm HK08
	100075	100382	3-01910	Bystronic Nozzle 1.0mm HK10
	100149	100383	3-01911	Bystronic Nozzle 1.2mm HK12
	100150	100384	3-01912	Bystronic Nozzle 1.5mm HK15
	100151	100388	3-01913	Bystronic Nozzle 1.7mm HK17
	100152	100389	3-01914	Bystronic Nozzle 2.0mm HK20
	100153	100557	3-01915	Bystronic Nozzle 2.5mm HK25
	100161	100558	3-06112	Bystronic Nozzle 3.0mm HK30

CP = Chrome Plated · HD = Tapered · STD = Standard

## Parts Bystronic®

Part	Part No.	OEM No.	Description
	100468	2-10837	Bystronic Nozzle Body
	060170	3-13422	Bystronic Insulator Ring with Holes
	200467	3-13110	Bystronic Copper Shield
	100477	3-06035	Bystronic Copper Shield
	200466	3-06035-T	Bystronic Teflon Disc
	060005	3-03663-T	Bystronic Teflon Disc
	060169	3-13113	Bystronic Insulating Ring - 32mm

American Laser Enterprises, LLC. is in no way affiliated with BYSTRONIC®. The parts advertised are not genuine BYSTRONIC® parts, but made for and by American Laser Enterprises, LLC. References to BYSTRONIC® machines and parts are for your convenience only. Corporate names and trademarks stated herein are the property of their respective companies.





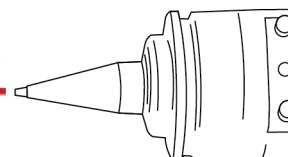



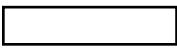

sales@a-l-e.net  
P:248 449 3714  
F:248 449 7631  
www.a-l-e.net

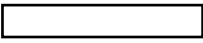
Contact Us





## Parts Bystronic®

Part	Part No.	OEM No.	Description
	060041	2-08701	Bystronic Nozzle Body - Extended Thread
	060042	4-09010	Bystronic Insulating Disc - Ceramic
	100343	2-08700	Bystronic Copper Shield
	060003	4-01642	Bystronic Insulating Disc - Ceramic
	100019	3-05497	Bystronic Nozzle Body
	060004	4-01959	Bystronic Cone - Ceramic
	050021	4-03137	Bystronic Pin
	050019	4-03136	Bystronic Knurled Screw
	050020	3-05530	Bystronic Scanner
	200468	2-01262	Bystronic Scanner
	070005	2-02015	Bystronic Scanner with Ring

American Laser Enterprises, LLC. is in no way affiliated with BYSTRONIC®. The parts advertised are not genuine BYSTRONIC® parts, but made for and by American Laser Enterprises, LLC. References to BYSTRONIC® machines and parts are for your convenience only. Corporate names and trademarks stated herein are the property of their respective companies.

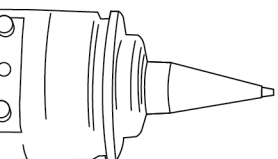







Contact Us

sales@a-l-e.net  
P:248 449 3714  
F:248 449 7631  
www.a-l-e.net

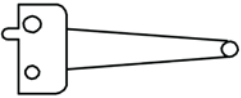

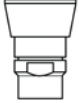

## Parts Bystronic®

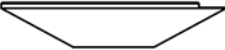
Part	Part No.	OEM No.	Description
	200462	2-02016	Bystronic Ball Scanner
	050685	4-04976	Bystronic Knurled Screw
	050022	4-00324	Bystronic Knurled Screw
	050802	3-09001	Bystronic Cross-Jet Screw
	200463	3-02291	Bystronic Nozzle Body (No Flats)
	200464	3-11071	Bystronic Fastening Nut
	200465	3-03663-C	Bystronic Copper Shield

## Standard Focusing Lenses and Optics

### Optics Bystronic

Part No.	OEM No.	Description
110111	4-00186	Lens D1.5 - f5.0 - .236ET - Meniscus
110112	4-00187	Lens D1.5 - f7.5 - .236ET - Meniscus
110113	4-05094	Lens D1.5 - f5.0 - .350ET - Meniscus
110114	4-05095	Lens D1.5 - f7.5 - .350ET - Meniscus

American Laser Enterprises, LLC. is in no way affiliated with BYSTRONIC®. The parts advertised are not genuine BYSTRONIC® parts, but made for and by American Laser Enterprises, LLC. References to BYSTRONIC® machines and parts are for your convenience only. Corporate names and trademarks stated herein are the property of their respective companies.

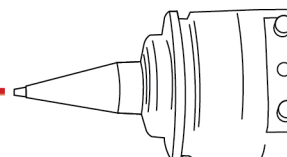

sales@a-l-e.net  
P:248 449 3714  
F:248 449 7631  
www.a-l-e.net

Contact Us





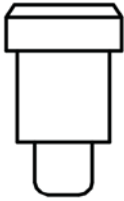

### Nozzles Cincinnati®

Part	Part No.	OEM No.	Description	
	100020	908090	Gas Jet Tip .062 - Length .898 (Contact)	
	100034	907469	Gas Jet Tip .040 - Length .898 (Contact)	
	100033	907470	Gas Jet Tip .062 - Length .873 (Contact)	
	100051	920006	Gas Jet Tip .080 - Length .873 (Contact)	
	100054	920141	Gas Jet Tip .090 - Length .873 (Contact)	
	100070	923789	Gas Jet Tip .100 - Length .873 (Contact)	
		100042	924635	Gas Jet Tip .040
100035		909660	Gas Jet Tip .060	
100053		910315	Gas Jet Tip .080	
100080		932789 / 924638	Gas Jet Tip .100	
100060		924634	Gas Jet Tip .120	
100072		923013	Gas Jet Tip .040 - Shower	
100071		923014	Gas Jet Tip .060 - Shower	
100470			Gas Jet Tip .080 - Shower	
		100336	924636	Gas Jet Tip .060 - High Capacitance
		100335	924637	Gas Jet Tip .080 - High Capacitance

CP = Chrome Plated • HD = Tapered • STD = Standard

### Parts Cincinnati®

Part	Part No.	OEM No.	Description
	130060	923258	Nozzle Body
	060011	923259	Insulator Ring
	160029 160028	907471 / 909364 907472 / 909367	Manifold Seal Ring - 1.5 Manifold Seal Ring - 2.0

American Laser Enterprises, LLC. is in no way affiliated with CINCINNATI®. The parts advertised are not genuine CINCINNATI® parts, but made for and by American Laser Enterprises, LLC. References to CINCINNATI® machines and parts are for your convenience only. Corporate names and trademarks stated herein are the property of their respective companies.

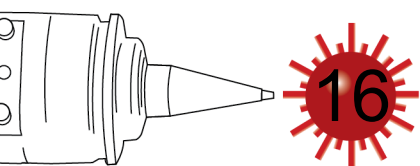



Contact Us

sales@a-l-e.net  
P:248 449 3714  
F:248 449 7631  
www.a-l-e.net

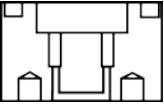

## Parts Cincinnati®

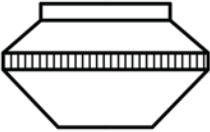
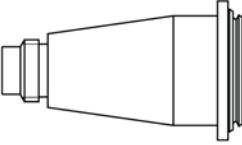
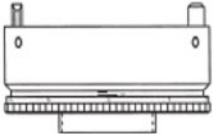
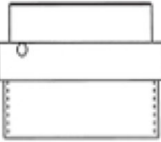
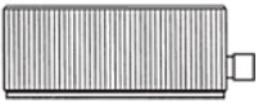
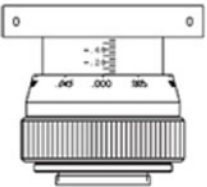
Part	Part No.	OEM No.	Description
	130011 130011G	907677 907677	Tip Retainer - Surface Follower Tip Retainer - Surface Follower with Seal Ring
	130031	909659	Tip Retainer Nut - Standard
	130059	923021	Tip Retainer Nut - Tapered
	130085 130087	909658 909681	Tip Retainer Extension - Long Tip Retainer Extension - Short
	150029	909635	Gas Jet Manifold - Composite Barrel
	150002	922408	Composite Sliding Barrel
	130024	922675	Tip Retainer Nut Assembly
	150032	923023	Gas Jet Manifold - HP

American Laser Enterprises, LLC. is in no way affiliated with CINCINNATI®. The parts advertised are not genuine CINCINNATI® parts, but made for and by American Laser Enterprises, LLC. References to CINCINNATI® machines and parts are for your convenience only. Corporate names and trademarks stated herein are the property of their respective companies.

sales@a-l-e.net  
P:248 449 3714  
F:248 449 7631  
www.a-l-e.net

Contact Us

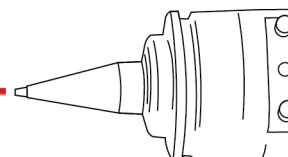

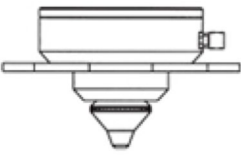
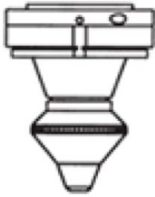
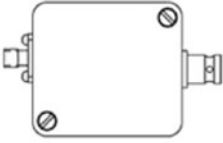
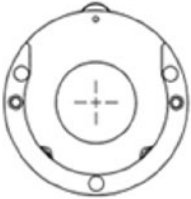
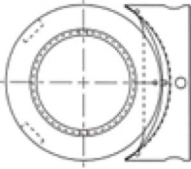

Parts Cincinnati®

Part	Part No.	OEM No.	Description
	130068 130062	923257	Sensor Assembly (Shield) - Saturn III Sensor Assembly (No Shield) - Saturn III
	120009	923411	Field Repair Kit - Saturn III
	070050	841836	Tip Transformer Assembly
	090057	923016	Lens Manifold Block
	090009	909359	Adjustable Lens Holder - D1.5

CP = Chrome Plated • HD = Tapered • STD = Standard

American Laser Enterprises, LLC. is in no way affiliated with CINCINNATI®. The parts advertised are not genuine CINCINNATI® parts, but made for and by American Laser Enterprises, LLC. References to CINCINNATI® machines and parts are for your convenience only. Corporate names and trademarks stated herein are the property of their respective companies.

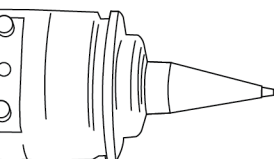

Contact Us

sales@a-l-e.net  
P:248 449 3714  
F:248 449 7631  
www.a-l-e.net





Standard Focusing Lenses and Optics

Optics Cincinnati

Part No.	OEM No.	Description
110092	908085	Lens D1.5 - WD5.13 - .280ET
110096	909484	Lens D1.5 - WD7.63 - .300ET

Sensor Cable Cincinnati



Part No.	070057
OEM / Reference No.	N/A
<b>Cincinnati Tip Transformer Wire 6.0 in.</b>	

Part No.	070057A
OEM / Reference No.	N/A
<b>Armordillo™ Cable for Cincinnati 6.0 in.</b> Long life. Thermally Resistant. Shielded. Pg 49.	

Sensor Cable Cincinnati



Part No.	070051
OEM / Reference No.	909654 / 922686
<b>Cincinnati Tip Transformer Wire 4.5 in.</b>	



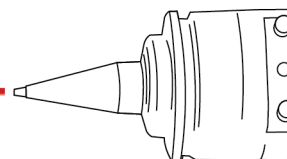

Part No.	070051A
OEM / Reference No.	909654 / 922686
<b>Armordillo™ Cable for Cincinnati 4.5 in.</b> Long life. Thermally Resistant. Shielded. Pg 49.	

American Laser Enterprises, LLC. is in no way affiliated with CINCINNATI®. The parts advertised are not genuine CINCINNATI® parts, but made for and by American Laser Enterprises, LLC. References to CINCINNATI® machines and parts are for your convenience only. Corporate names and trademarks stated herein are the property of their respective companies.





## Nozzles Mazak®

Part	Part No.	OEM No.	Description
	100201	46603350508	Mazak Nozzle 0.8mm
	100193	46603350511	Mazak Nozzle 1.0mm
	100194	46603350512	Mazak Nozzle 1.2mm
	100076	46603350520	Mazak Nozzle 1.5mm
	100195	46603350517	Mazak Nozzle 1.7mm
	100196	46603350522	Mazak Nozzle 2.0mm
	100197	46603350525	Mazak Nozzle 2.5mm
	100198	46603350530	Mazak Nozzle 3.0mm
	100365	46603350523-08	Mazak Nozzle 0.8mm (Shower)
100471	46603350523-10	Mazak Nozzle 1.0mm (Shower)	
100077	46603350523-15	Mazak Nozzle 1.5mm (Shower)	
	100333	46603350521	Mazak Nozzle 1.0mm - Tapered
	100269	46603350520	Mazak Nozzle 1.5mm - Tapered
	100270	46603350522	Mazak Nozzle 2.0mm - Tapered
	100273	46603350522-2.5	Mazak Nozzle 2.5mm - Tapered
	100247	46683301810	Mazak Side Blow Nozzle 1.0mm
	100248	46683301950	Mazak Side Blow Nozzle 1.5mm
	100249	46683301821	Mazak Side Blow Nozzle 2.0mm
	100250	46683301960	Mazak Side Blow Nozzle 2.5mm
	100268	46683301970	Mazak Side Blow Nozzle 3.0mm
	100527	46143304470	Mazak Nozzle HG 1.2mm - CP
	100528	46143304450	Mazak Nozzle HG 1.5mm - CP
	100529	46143304460	Mazak Nozzle HG 2.0mm - CP
	100530	46143304480	Mazak Nozzle HG 2.5mm - CP
	100531	46143304490	Mazak Nozzle HG 3.0mm - CP
	100532	46143304500	Mazak Nozzle HG 3.5mm - CP
	100534	46143304510	Mazak Nozzle HG 4.0mm - CP
	100535		Mazak Double Nozzle HG 1.2mm - CP
	100536		Mazak Double Nozzle HG 1.5mm - CP
	100537		Mazak Double Nozzle HG 2.0mm - CP

CP = Chrome Plated • HD = Tapered • STD = Standard

American Laser Enterprises, LLC. is in no way affiliated with MAZAK®. The parts advertised are not genuine MAZAK® parts, but made for and by American Laser Enterprises, LLC. References to MAZAK® machines and parts are for your convenience only. Corporate names and trademarks stated herein are the property of their respective companies.

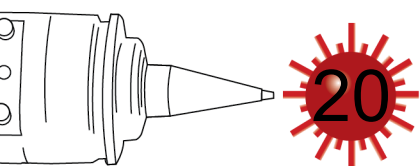





Contact Us

sales@a-l-e.net  
P:248 449 3714  
F:248 449 7631  
www.a-l-e.net

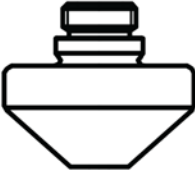

## Nozzles Mazak®

Part	Part No.	OEM No.	Description
	100518 100519 100520 100521		Mazak Nozzle HG 1.0mm - Long Mazak Nozzle HG 1.2mm - Long Mazak Nozzle HG 1.5mm - Long Mazak Nozzle HG 2.0mm - Long
	100522 100523 100524 100525 100526		Mazak Nozzle HG 1.0mm Mazak Nozzle HG 1.2mm Mazak Nozzle HG 1.5mm Mazak Nozzle HG 2.0mm Mazak Nozzle HG 3.0mm
	100491 100444 100323 100328 100429 100430	46713300290 46713300280	Mazak Nozzle 3D 1.0mm Mazak Nozzle 3D 1.2mm Mazak Nozzle 3D 1.5mm Mazak Nozzle 3D 2.0mm Mazak Nozzle 3D 2.5mm Mazak Nozzle 3D 3.0mm
	100467 100423 100422 100442 100469	46713300310 46713300300	Mazak Nozzle 1.2mm 2D Mazak Nozzle 1.5mm 2D Mazak Nozzle 2.0mm 2D Mazak Nozzle 2.5mm 2D Mazak Nozzle 3.0mm 2D
	100235 100236 100237 100238 100239 100448		Mazak Nozzle ZK 1.0mm Mazak Nozzle ZK 1.2mm Mazak Nozzle ZK 1.5mm Mazak Nozzle ZK 1.8mm Mazak Nozzle ZK 2.0mm Mazak Nozzle ZK 2.5mm
	100230 100231 100232 100233 100234		Mazak Nozzle KK 1.0mm Mazak Nozzle KK 1.2mm Mazak Nozzle KK 1.5mm Mazak Nozzle KK 1.8mm Mazak Nozzle KK 2.0mm

CP = Chrome Plated • HD = Tapered • STD = Standard

American Laser Enterprises, LLC. is in no way affiliated with MAZAK®. The parts advertised are not genuine MAZAK® parts, but made for and by American Laser Enterprises, LLC. References to MAZAK® machines and parts are for your convenience only. Corporate names and trademarks stated herein are the property of their respective companies.





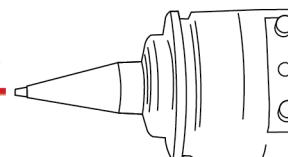

sales@a-l-e.net  
P:248 449 3714  
F:248 449 7631  
www.a-l-e.net

Contact Us

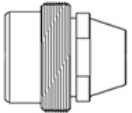
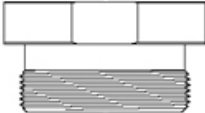
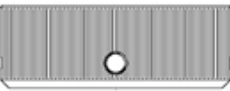



Parts Mazak®

Part	Part No.	OEM No.	Description
	050048	46683300030	Mazak Retainer Nut
	040029	46603350510	Mazak Tip Adapter - Brass
	200057	46523300080	Mazak Centering Hub
	160015	46683300930	Mazak Ring
	050047	46603300032	Mazak Bolt M5 X 0.5
	200052	36673300280	Mazak Breakaway Bar 60mm
	200071	36572301012	Mazak Breakaway Bar 61mm
	200051	36602300230	Mazak Breakaway Bar 89mm
	200470	36682300281	Mazak Stylus Arm

American Laser Enterprises, LLC. is in no way affiliated with MAZAK®. The parts advertised are not genuine MAZAK® parts, but made for and by American Laser Enterprises, LLC. References to MAZAK® machines and parts are for your convenience only. Corporate names and trademarks stated herein are the property of their respective companies.

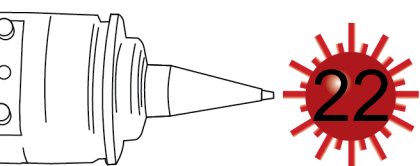







Contact Us

sales@a-l-e.net  
P:248 449 3714  
F:248 449 7631  
www.a-l-e.net



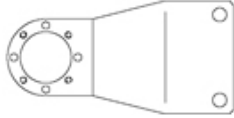

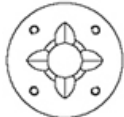
## Parts Mazak®

Part	Part No.	OEM No.	Description
	200049	36602300580	Mazak Stylus Arm - Proxy Switch
	200050	36682300050	Mazak Stylus Arm
	200161	36602350020	Mazak Stylus Arm - High Version
	200156	46522300250	Mazak Stylus Arm - Pin Style
	200056	46512300520	Mazak Brass Stylus Foot - 4mm
	200058 200047 200048	46572301041 46572301041S 46572301041T	Mazak Brass Stylus Foot - 12mm Mazak Steel Stylus Foot - 12mm Mazak Teflon Stylus Foot - 12mm
	200059 200061	46572301043 46602350080	Mazak Steel Stylus Foot - 9mm Mazak Brass Stylus Foot - 9mm
	200060	46572301045 46572301043 46572350080	Mazak Teflon Stylus Foot - 9mm Mazak Steel Stylus Foot - 9mm Mazak Brass Stylus Foot - 9mm

American Laser Enterprises, LLC. is in no way affiliated with MAZAK®. The parts advertised are not genuine MAZAK® parts, but made for and by American Laser Enterprises, LLC. References to MAZAK® machines and parts are for your convenience only. Corporate names and trademarks stated herein are the property of their respective companies.





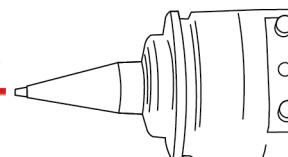

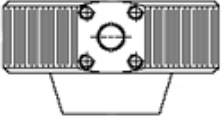

sales@a-l-e.net  
P:248 449 3714  
F:248 449 7631  
www.a-l-e.net

Contact Us



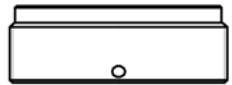

Parts Mazak®

Part	Part No.	OEM No.	Description
	200065	46683301140	Mazak Aluminum Housing
	160018	46683301160	Mazak Copper Ring
	170003	46683301150	Mazak Teflon Spacer
	200067	46683301841	Mazak Teflon Cover - Side Blow
	200072	46683301930	Mazak Teflon Cover - New Style
	160017	46683301130	Mazak Teflon Ring
	060175	4671330200	Mazak Insulating Ring - New
	160016	46683301120	Mazak Teflon Ring

American Laser Enterprises, LLC. is in no way affiliated with MAZAK®. The parts advertised are not genuine MAZAK® parts, but made for and by American Laser Enterprises, LLC. References to MAZAK® machines and parts are for your convenience only. Corporate names and trademarks stated herein are the property of their respective companies.

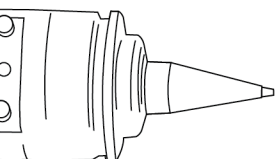







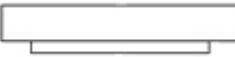

Contact Us

sales@a-l-e.net  
P:248 449 3714  
F:248 449 7631  
www.a-l-e.net

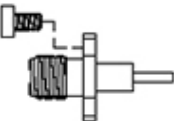
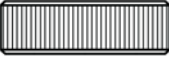
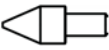
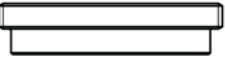

## Parts Mazak®

Part	Part No.	OEM No.	Description
	200063	46683301100	Mazak Copper Bracket
	160014	46683301090	Mazak Teflon Ring
	200062	46683301070	Mazak Brass Base
	160012	46683301080	Mazak Teflon Ring
	200055	46683301110	Mazak Top Bracket
	200073	46683301851	Mazak Teflon Connector Cover - SMA
	200066 050049 050050	46683301170 46683300000 46683301180	Mazak Connector - SMA Mazak Screw M2.5 X 4 Mazak Set Screw
	050813	46583301720	Mazak Retainer Nut
	050814	46600030013	Mazak Table Pin
	090106		Mazak Mount for Lens 2.0"
	0400044	46522300242	Mazak Stylus Pin

American Laser Enterprises, LLC. is in no way affiliated with MAZAK®. The parts advertised are not genuine MAZAK® parts, but made for and by American Laser Enterprises, LLC. References to MAZAK® machines and parts are for your convenience only. Corporate names and trademarks stated herein are the property of their respective companies.





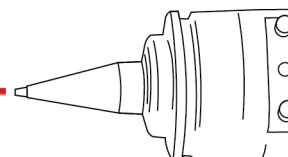

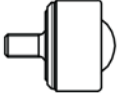
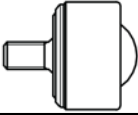

sales@a-l-e.net  
P:248 449 3714  
F:248 449 7631  
www.a-l-e.net

Contact Us



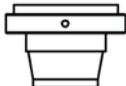
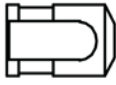

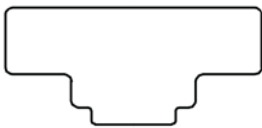
Parts Mazak®

Part	Part No.	OEM No.	Description
	200069	Z21KV000580	Mazak Table Roller
	200471	Z21ZZ001160	Mazak Table Roller - Big
	200070	46575100321	Mazak Bearing Block - 42mm
	200123	46705100050	Mazak Bearing Block - 66mm
	200473		Mazak Bearing Block - 61mm
	200064	46683300850	Mazak Nozzle Body
	200472	46683300720	Mazak Nozzle Body - Special
	200147	46683301860	Mazak Teflon Cable Connector Cover
	200148	46683301870	Mazak Teflon Cover Clip
	040030	46683301230	Mazak Plate
	130102	46713300321	Mazak Vespel Nut - Space Gear <b>Note:</b> Aluminum Available

American Laser Enterprises, LLC. is in no way affiliated with MAZAK®. The parts advertised are not genuine MAZAK® parts, but made for and by American Laser Enterprises, LLC. References to MAZAK® machines and parts are for your convenience only. Corporate names and trademarks stated herein are the property of their respective companies.

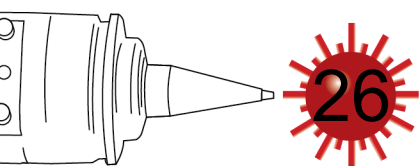

Contact Us

sales@a-l-e.net  
P:248 449 3714  
F:248 449 7631  
www.a-l-e.net



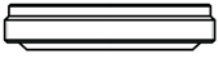

### Parts Mazak®

Part	Part No.	OEM No.	Description
	060015 060040		Mazak Plastic Insulating Ring - Original Mazak Plastic Insulating Ring - Nylon

### Assembly Mazak®

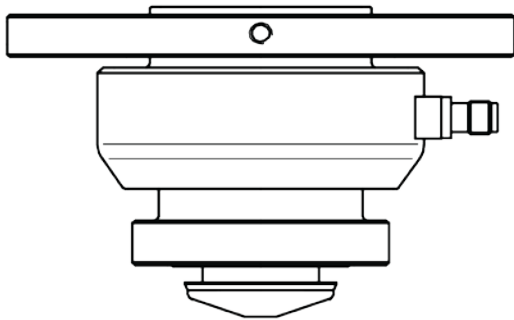

Part No.	140022
OEM / Reference No.	
<b>Mazak® HYPERGEAR Torch</b> with Ceramic	

**Don't need the whole assembly?** Select from our comprehensive inventory of quality spare parts. With same day shipping and the most competitive prices in the industry, we can keep your MAZAK® beam deliver system producing.

### Parts Mazak®

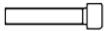



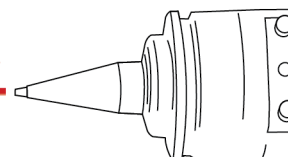



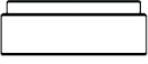

Part	Part No.	OEM No.	Description
	050798	A06CB040200	Mazak HG Set Screw for Head (4)

American Laser Enterprises, LLC. is in no way affiliated with MAZAK®. The parts advertised are not genuine MAZAK® parts, but made for and by American Laser Enterprises, LLC. References to MAZAK® machines and parts are for your convenience only. Corporate names and trademarks stated herein are the property of their respective companies.

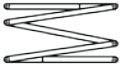

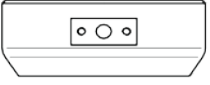

## Parts Mazak®

Part	Part No.	OEM No.	Description
	100488	36143304420	Mazak HG Nozzle Adapter HTX
	100489	36143304400	Mazak HG Coupler
	130131	46143304430	Mazak HG Spring Retainer
	050795	46143300230	Mazak HG Ball Kit (6)
	130124	46143308000	Mazak HG Coupler Ring
	050796	46143300220	Mazak HG Spring
	130129	36143303242	Mazak HG Body
	130127	36143307980	Mazak HG Aluminum Body
	050797	46603300030	Mazak HG Screw for Connector (2)
	170033	46143308170	Mazak HG Aluminum Spacer for Connector
	070016	46143308190	Mazak HG Connector

American Laser Enterprises, LLC. is in no way affiliated with MAZAK®. The parts advertised are not genuine MAZAK® parts, but made for and by American Laser Enterprises, LLC. References to MAZAK® machines and parts are for your convenience only. Corporate names and trademarks stated herein are the property of their respective companies.

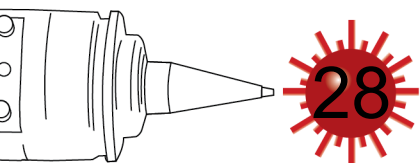

Contact Us

sales@a-l-e.net  
P:248 449 3714  
F:248 449 7631  
www.a-l-e.net



## Parts Mazak®

Part	Part No.	OEM No.	Description
	060172	46143300240	Mazak HG 40X5 Insulator
	130128	46143304250	Mazak HG Retainer Nut with Amplifier Hole 2.0
	130126	46143307420	Mazak HG Retainer Nut with Amplifier Hole 1.4
	050799	46143301180	Mazak HG Screw
	060171	46143304440	Mazak HG 40X6 Insulator
	130132	46143300290	Mazak HG Retainer Nut
	060173	46143300260	Mazak HG 40X4 Insulator
	060174	46143300270	Mazak HG 38X5.5 Insulator
	1310133	46143300280	Mazak HG Retainer Nut with Cone
	130122	46143300320	Mazak HG Brass Ring
	130125	36143300332	Mazak HG Aluminum Ring

American Laser Enterprises, LLC. is in no way affiliated with MAZAK®. The parts advertised are not genuine MAZAK® parts, but made for and by American Laser Enterprises, LLC. References to MAZAK® machines and parts are for your convenience only. Corporate names and trademarks stated herein are the property of their respective companies.

sales@a-l-e.net  
P:248 449 3714  
F:248 449 7631  
www.a-l-e.net

Contact Us

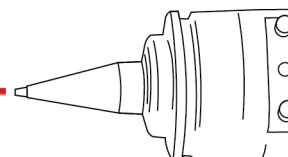

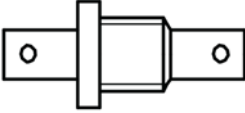

### Parts Mazak®

Part	Part No.	OEM No.	Description
	040032	D60RA012460	Mazak Sensor Cable Adapter

### Standard Focusing Lenses and Optics

#### Optics Mazak

Part No.	OEM No.	Description
110116	Z50ZZ000400	Lens D1.5 - f5.0 - .300ET
110123	Z50ZZ005160A	Lens D2.0 - f5.0 - .380ET
110106	Z50ZZ005200	Lens D2.0 - f7.5 - .380ET

#### Sensor Cable Mazak

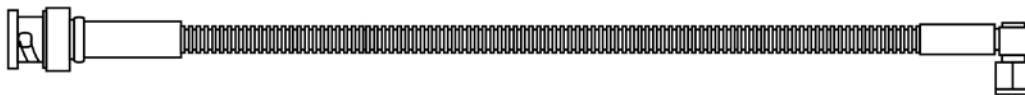

Part No.	200068
OEM / Reference No.	46683301980
<b>Mazak Sensor Cable 11 in.</b>	

Part No.	070074
OEM / Reference No.	46683301330
<b>Mazak Long Sensor Cable 12 in.</b>	

Part No.	200068A
OEM / Reference No.	46683301980
<b>Armordillo™ Cable for Mazak Sensor Cable</b>	
Long life. Thermally Resistant. Shielded. Pg 49.	

Part No.	070074A
OEM / Reference No.	46683301330
<b>Armordillo™ Cable for Mazak Long Sensor Cable</b>	
Long life. Thermally Resistant. Shielded. Pg 49.	

American Laser Enterprises, LLC. is in no way affiliated with MAZAK®. The parts advertised are not genuine MAZAK® parts, but made for and by American Laser Enterprises, LLC. References to MAZAK® machines and parts are for your convenience only. Corporate names and trademarks stated herein are the property of their respective companies.

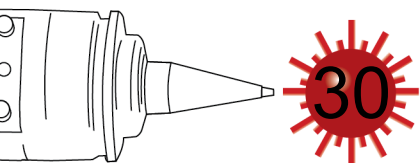



Contact Us

sales@a-l-e.net  
P:248 449 3714  
F:248 449 7631  
www.a-l-e.net

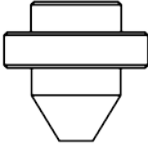
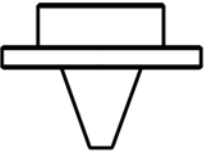
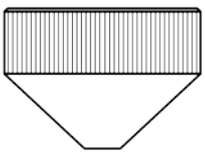

## Nozzles Mitsubishi®

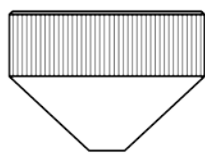
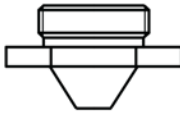
Part	Part No.	OEM No.	Description
	100224	W777	Mitsubishi Single Hole Nozzle 1.0mm
	100226	W266	Mitsubishi Single Hole Nozzle 1.5mm
	100227	W267	Mitsubishi Single Hole Nozzle 2.0mm
	100229	W776	Mitsubishi Single Hole Nozzle 2.5mm
	100228	W268	Mitsubishi Single Hole Nozzle 3.0mm
	100087	W390	Mitsubishi 4 Hole Double Nozzle
	100088	W270	Mitsubishi 8 Hole Double Nozzle
	100089	W387	Mitsubishi 12 Hole Double Nozzle
	100090	W388	Mitsubishi 16 Hole Double Nozzle
	100091	W515	Mitsubishi 24 Hole Double Nozzle
	100258	W1249	Mitsubishi Shield Nozzle 1.0mm
	100272	W1256	Mitsubishi Shield Nozzle 1.2mm
	100309	W1250	Mitsubishi Shield Nozzle 1.5mm
	100283	W1251	Mitsubishi Shield Nozzle 2.0mm
	100311	W1252	Mitsubishi Shield Nozzle 2.5mm
	100312	W1253	Mitsubishi Shield Nozzle 3.0mm
	100313	W1254	Mitsubishi Shield Nozzle 3.5mm
	100314	W1255	Mitsubishi Shield Nozzle 4.0mm
	100240	W222	Mitsubishi Nozzle 0.8mm
	100241	W223	Mitsubishi Nozzle 1.0mm
	100242	W228	Mitsubishi Nozzle 1.2mm
	100222	W224	Mitsubishi Nozzle 1.5mm
	100243	W225	Mitsubishi Nozzle 2.0mm
	100461	W1626	Mitsubishi Shield Nozzle 1.0mm (Short)
	100462	W1627	Mitsubishi Shield Nozzle 1.2mm (Short)
	100463	W1628	Mitsubishi Shield Nozzle 1.5mm (Short)
	100464	W1629	Mitsubishi Shield Nozzle 2.0mm (Short)
	100474	W1630	Mitsubishi Shield Nozzle 2.5mm (Short)
	100465	W1664	Mitsubishi Shield Nozzle 3.0mm (Short)
	100346	W001	Mitsubishi Nozzle 1.5mm
	100347	W002	Mitsubishi Nozzle 2.0mm
	100348	W004	Mitsubishi Nozzle 2.5mm
	100349	W003	Mitsubishi Nozzle 3.0mm

CP = Chrome Plated • HD = Tapered • STD = Standard

American Laser Enterprises, LLC. is in no way affiliated with MITSUBISHI®. The parts advertised are not genuine MITSUBISHI® parts, but made for and by American Laser Enterprises, LLC. References to MITSUBISHI® machines and parts are for your convenience only. Corporate names and trademarks stated herein are the property of their respective companies.

sales@a-l-e.net  
P:248 449 3714  
F:248 449 7631  
www.a-l-e.net

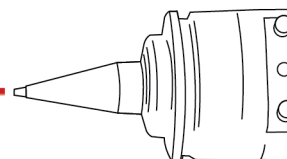

Contact Us





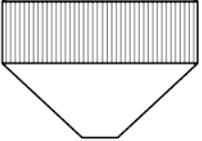

**Parts Mitsubishi®**

Part	Part No.	OEM No.	Description
	100289	W269	Mitsubishi Lock Nut - Multi Hole
	060045	W149	Mitsubishi Ceramic Nozzle Holder
	050052	W263	Mitsubishi Lock Nut - Single Hole

 Standard Focusing Lenses and Optics 

**Optics Mitsubishi**

Part No.	OEM No.	Description
110144	W500	Lens D1.5 - f5.0 - .310ET
110169	W505	Lens D2.0 - f5.0 - .310ET
110122	W510	Lens D2.0 - f7.5 - .310ET

American Laser Enterprises, LLC. is in no way affiliated with MITSUBISHI®. The parts advertised are not genuine MITSUBISHI® parts, but made for and by American Laser Enterprises, LLC. References to MITSUBISHI® machines and parts are for your convenience only. Corporate names and trademarks stated herein are the property of their respective companies.

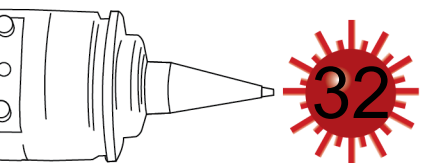

Contact Us

sales@a-l-e.net  
P:248 449 3714  
F:248 449 7631  
www.a-l-e.net



## Nozzles Precitec®

Part	Part No.	OEM No.	Description
	100132	P0591-561-00010	Precitec Nozzle 1.0mm DE HP1.5
	100262	P0591-562-00012	Precitec Nozzle 1.2mm DE HP1.5
	100133	P0591-563-00015	Precitec Nozzle 1.5mm DE HP1.5
	100266	P0591-564-00018	Precitec Nozzle 1.8mm DE HP1.5
	100134	P0591-565-00020	Precitec Nozzle 2.0mm DE HP1.5
	100267	P0591-566-00025	Precitec Nozzle 2.5mm DE HP1.5
	100205	P0571-281-00010	Precitec Nozzle 1.0mm DE B2
	100206	P0571-283-00015	Precitec Nozzle 1.5mm DE B2
	100207	P0571-285-00020	Precitec Nozzle 2.0mm DE B2
	100440	P0571-286-00025	Precitec Nozzle 2.5mm DE B2
	100345	P0571-293-00015	Precitec Nozzle 1.5mm DE B2 - CON
	100129	P0494-853-00010	Precitec Nozzle 1.0mm DE M1.5 KN
	100130	P0494-854-00012	Precitec Nozzle 1.2mm DE M1.5 KN
	100131	P0494-855-00015	Precitec Nozzle 1.5mm DE M1.5 KN
	100235	P0352-323-00010	Precitec Nozzle 1.0mm CH ZK
	100236	P0352-324-00012	Precitec Nozzle 1.2mm CH ZK
	100237	P0352-325-00015	Precitec Nozzle 1.5mm CH ZK
	100238	P0352-326-00018	Precitec Nozzle 1.8mm CH ZK
	100239	P0352-327-00020	Precitec Nozzle 2.0mm CH ZK
	100448	P0352-328-00025	Precitec Nozzle 2.5mm CH ZK
	100230	P0352-333-00010	Precitec Nozzle 1.0mm CH KK
	100231	P0352-334-00012	Precitec Nozzle 1.2mm CH KK
	100232	P0352-335-00015	Precitec Nozzle 1.5mm CH KK
	100233	P0352-336-00018	Precitec Nozzle 1.8mm CH KK
	100234	P0352-336-00020	Precitec Nozzle 2.0mm CH KK
	100491	P0352-381-00010	Precitec Nozzle 1.0mm DE M1.5 3D
	100444	P0352-384-00012	Precitec Nozzle 1.2mm DE M1.5 3D
	100323	P0352-381-00015	Precitec Nozzle 1.5mm DE M1.5 3D
	100328	P0352-382-00020	Precitec Nozzle 2.0mm DE M1.5 3D
	100429	P0352-382-00025	Precitec Nozzle 2.5mm DE M1.5 3D
	100430	P0352-382-00030	Precitec Nozzle 3.0mm DE M1.5 3D

CP = Chrome Plated • HD = Tapered • STD = Standard

American Laser Enterprises, LLC. is in no way affiliated with PRECITEC®. The parts advertised are not genuine PRECITEC® parts, but made for and by American Laser Enterprises, LLC. References to PRECITEC® machines and parts are for your convenience only. Corporate names and trademarks stated herein are the property of their respective companies.

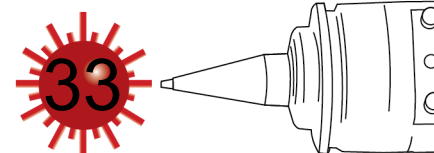

sales@a-l-e.net  
P:248 449 3714  
F:248 449 7631  
www.a-l-e.net

Contact Us



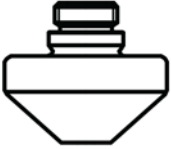
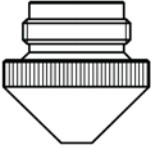
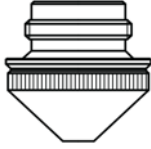
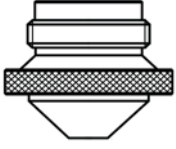

## Nozzles Precitec®

Part	Part No.	OEM No.	Description
	100467	P0352-386-00012	Precitec Nozzle 1.2mm DE M1.5 2D
	100423	P0352-386-00015	Precitec Nozzle 1.5mm DE M1.5 2D
	100422	P0352-387-00020	Precitec Nozzle 2.0mm DE M1.5 2D
	100442	P0352-387-00025	Precitec Nozzle 2.5mm DE M1.5 2D
	100469	P0352-387-00030	Precitec Nozzle 3.0mm DE M1.5 2D
	100437	P0352-387-00036	Precitec Nozzle 3.6mm DE M1.5 2D
	100397	P0380-251-00010	Precitec Nozzle 1.0mm DL M1.5
	100398	P0380-252-00012	Precitec Nozzle 1.2mm DL M1.5
	100399	P0380-253-00015	Precitec Nozzle 1.5mm DL M1.5
	100400	P0380-254-00020	Precitec Nozzle 2.0mm DL M1.5
	100401	P0380-255-00025	Precitec Nozzle 2.5mm DL M1.5
	100127	P0492-628-00010	Precitec Nozzle 1.0mm DXN M1.5 - L16.5
	100128	P0492-629-00012	Precitec Nozzle 1.2mm DXN M1.5 - L16.5
	100126	P0492-627-00015	Precitec Nozzle 1.5mm DXN M1.5 - L15.5
	100199	P0492-626-00020	Precitec Nozzle 2.0mm DXN M1.5 - L14.5
	100125	P0492-625-00025	Precitec Nozzle 2.5mm DXN M1.5 - L13.5
	100180	D7945470 / P0381-361-00010	Precitec LVD Nozzle 1.0mm - STD.
	100436	D5241982	Precitec LVD Nozzle 1.2mm - STD.
	100175	D7945434 / P0380-364-00015	Precitec LVD Nozzle 1.5mm - STD.
	100176	D7945452 / P0380-366-00020	Precitec LVD Nozzle 2.0mm - STD.
	100424	D7945517	Precitec LVD Nozzle 2.5mm - STD.
	100425	D7945517-3.0	Precitec LVD Nozzle 3.0mm - STD.
	100426	D5241863	Precitec LVD Nozzle 1.0mm - HP
	100427	D5241862	Precitec LVD Nozzle 1.5mm - HP
	100177	D5241855 / P0380-365-00020	Precitec LVD Nozzle 2.0mm - HP
	100178	D5241856 / P0380-367-00025	Precitec LVD Nozzle 2.5mm - HP
	100179	D5241857 / P0380-368-00030	Precitec LVD Nozzle 3.0mm - HP
	100202	P0591-571-00010	Precitec Nozzle 1.0mm DE HP1.5 - CON
	100264	P0591-572-00012	Precitec Nozzle 1.2mm DE HP1.5 - CON
	100203	P0591-573-00015	Precitec Nozzle 1.5mm DE HP1.5 - CON
	100204	P0591-575-00020	Precitec Nozzle 2.0mm DE HP1.5 - CON
	100263	P0591-576-00025	Precitec Nozzle 2.5mm DE HP1.5 - CON

CP = Chrome Plated • HD = Tapered • STD = Standard

American Laser Enterprises, LLC. is in no way affiliated with PRECITEC®. The parts advertised are not genuine PRECITEC® parts, but made for and by American Laser Enterprises, LLC. References to PRECITEC® machines and parts are for your convenience only. Corporate names and trademarks stated herein are the property of their respective companies.

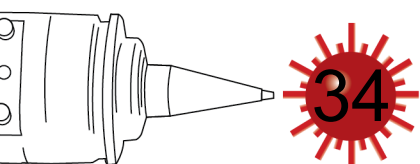







Contact Us

sales@a-l-e.net  
P:248 449 3714  
F:248 449 7631  
www.a-l-e.net

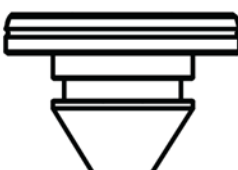

## Nozzles Trumpf®

Part	Part No.	OEM No.	Description
	100099	124561	Trumpf Nozzle 0.8mm - STD
	100100	124562	Trumpf Nozzle 1.0mm - STD
	100456	966809	Trumpf Nozzle 1.2mm - STD
	100121	237500	Trumpf Nozzle 1.5mm - STD
	100101	124565	Trumpf Nozzle 3.0mm - STD
	100136	237497-S	Trumpf Nozzle 1.4mm - HD
	100122	237501	Trumpf Nozzle 1.7mm - HD
	100123	237503	Trumpf Nozzle 2.0mm - HD
	100102	126933	Trumpf Nozzle 2.3mm - HD
	100120	237497	Trumpf Nozzle 1.4mm - Special HD
	100390	352280	Trumpf Nozzle 0.8mm - STD CP
	100391	352281	Trumpf Nozzle 1.0mm - STD CP
	100392	352282	Trumpf Nozzle 1.2mm - STD CP
	100385	352283	Trumpf Nozzle 1.4mm - HD CP
	100386	352284	Trumpf Nozzle 1.7mm - HD CP
	100387	352285	Trumpf Nozzle 2.3mm - HD CP
	100097	088893	Trumpf Nozzle 1.5mm - Thick Sheet
	100114	221781	Trumpf Nozzle 2.0mm - Thick Sheet
	100109	215780	Trumpf Nozzle 0.8mm - STD
	100096	087658	Trumpf Nozzle 1.0mm - STD
	100098	088894	Trumpf Nozzle 1.4mm - HD
	100111	217867-5	Trumpf Nozzle 1.7mm - HD
	100104	202952	Trumpf Nozzle 0.8mm
	100113	218969	Trumpf Nozzle 1.0mm
	100105	209402	Trumpf Nozzle 1.4mm - HD
	100112	217953	Trumpf Nozzle 1.7mm - HD

CP = Chrome Plated • HD = Tapered • STD = Standard

American Laser Enterprises, LLC. is in no way affiliated with TRUMPF®. The parts advertised are not genuine TRUMPF® parts, but made for and by American Laser Enterprises, LLC. References to TRUMPF® machines and parts are for your convenience only. Corporate names and trademarks stated herein are the property of their respective companies.





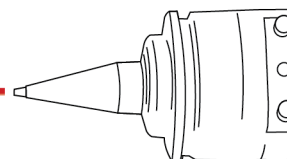

sales@a-l-e.net  
P:248 449 3714  
F:248 449 7631  
www.a-l-e.net

Contact Us



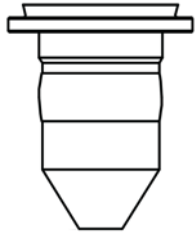

## Nozzles Trumpf®

Part	Part No.	OEM No.	Description
	100107 100110 100115 100455	212334 216199 225213 126156	Trumpf Nozzle 1.0mm Trumpf Nozzle 1.4mm Trumpf Nozzle 1.7mm Trumpf Nozzle 2.3mm
	100116 100117 100118	226939 226940 227144	Trumpf Nozzle 1.0mm Trumpf Nozzle 1.4mm Trumpf Nozzle 1.7mm
	100162 100163 100164	060653-08 060653-10 060653-14	Trumpf Nozzle 0.8mm Trumpf Nozzle 1.0mm Trumpf Nozzle 1.4mm
	100402 100403 100404	135320 135318 126157	Trumpf Nozzle 1.0mm - Knurled Flared Trumpf Nozzle 1.4mm - Knurled Flared Trumpf Nozzle 1.7mm - Knurled Flared
	100168 100103 100261	135320 135318 126157	Trumpf Nozzle 1.0mm - Hex Flared Trumpf Nozzle 1.4mm - Hex Flared Trumpf Nozzle 1.7mm - Hex Flared
	100107 100110 100115 100455 100119	212334 216199 225213 126156 237364	Trumpf Nozzle 1.0mm - Hex Tapered STD Trumpf Nozzle 1.4mm - Hex Tapered HD Trumpf Nozzle 1.7mm - Hex Tapered HD Trumpf Nozzle 2.3mm - Hex Tapered HD Trumpf Nozzle 1.0mm - Hex Tapered Shower
	100405	913803	Trumpf Nozzle 2.3mm

CP = Chrome Plated · HD = Tapered · STD = Standard

American Laser Enterprises, LLC. is in no way affiliated with TRUMPF®. The parts advertised are not genuine TRUMPF® parts, but made for and by American Laser Enterprises, LLC. References to TRUMPF® machines and parts are for your convenience only. Corporate names and trademarks stated herein are the property of their respective companies.

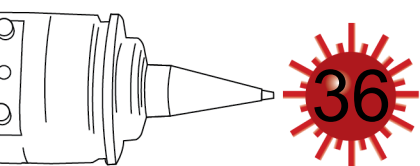





Contact Us

sales@a-l-e.net  
P:248 449 3714  
F:248 449 7631  
www.a-l-e.net



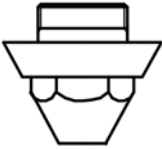
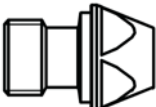

## Nozzles Trumpf®

Part	Part No.	OEM No.	Description
	100406 100407 100408 100409 100410	913799 913800 913801 937988 937989	Trumpf Nozzle 0.8mm - TLC (HD) Trumpf Nozzle 1.0mm - TLC (HD) Trumpf Nozzle 1.4mm - TLC (HD) Trumpf Nozzle 1.7mm - TLC (HD) Trumpf Nozzle 2.3mm - TLC (HD)
	100119	237364	Trumpf Nozzle 1.0mm - Shower
	100548 100549		Trumpf Nozzle 2.3mm HD H=4 Trumpf Nozzle 2.3mm HD H=3.5
	100550	932530	Trumpf Nozzle 4.5mm - CP
	100551	924947	Trumpf Welding Nozzle M10
	100552	220783	Trumpf Welding Nozzle M18

CP = Chrome Plated • HD = Tapered • STD = Standard

American Laser Enterprises, LLC. is in no way affiliated with TRUMPF®. The parts advertised are not genuine TRUMPF® parts, but made for and by American Laser Enterprises, LLC. References to TRUMPF® machines and parts are for your convenience only. Corporate names and trademarks stated herein are the property of their respective companies.





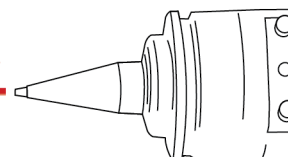

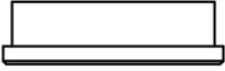

sales@a-l-e.net  
P:248 449 3714  
F:248 449 7631  
www.a-l-e.net

Contact Us



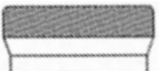

Parts Trumpf®

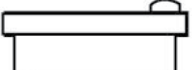
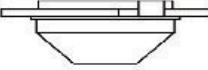
Part	Part No.	OEM No.	Description
	200475		Trumpf Stylus Foot
	200476	216086	Trumpf Stylus Foot
	060024	225286	Trumpf Teflon Cover
	060029	254496	Trumpf Teflon Cover
	060028	256153	Trumpf Teflon Cover
	200160	234485	Trumpf Break Away Ring
	130104	913965	Trumpf Retainer Nut
	160040	216066	Trumpf Lock Nut
	060025	243839 / 258809	Trumpf Ceramic Nozzle Holder - Small
	060023	216065	Trumpf Teflon Cover

American Laser Enterprises, LLC. is in no way affiliated with TRUMPF®. The parts advertised are not genuine TRUMPF® parts, but made for and by American Laser Enterprises, LLC. References to TRUMPF® machines and parts are for your convenience only. Corporate names and trademarks stated herein are the property of their respective companies.

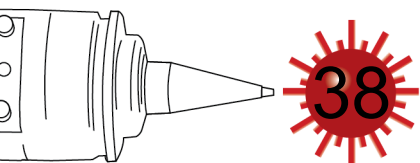

Contact Us

sales@a-l-e.net  
P:248 449 3714  
F:248 449 7631  
www.a-l-e.net

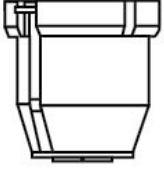
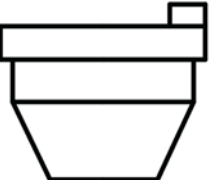

### Parts Trumpf®

Part	Part No.	OEM No.	Description
	060044 060027	092405 260432 / 254493	Trumpf Ceramic Nozzle Holder Trumpf Ceramic Nozzle Holder - Large
	060051	0936678	Trumpf Ceramic Nozzle Holder

### Standard Focusing Lenses and Optics

### Optics Trumpf®

Part No.	OEM No.	Description
110109	088114	Lens D1.5 - f5.0 - .291ET - Meniscus
110110	097517	Lens D1.5 - f7.5 - .291ET - Meniscus

American Laser Enterprises, LLC. is in no way affiliated with TRUMPF®. The parts advertised are not genuine TRUMPF® parts, but made for and by American Laser Enterprises, LLC. References to TRUMPF® machines and parts are for your convenience only. Corporate names and trademarks stated herein are the property of their respective companies.

sales@a-l-e.net  
P:248 449 3714  
F:248 449 7631  
www.a-l-e.net

Contact Us

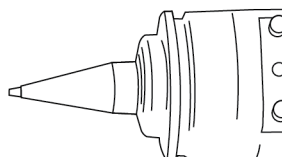



**Optics**

Part No.	OEM No.	Description
<b>Amada</b>		
110115	81140303	Lens D1.1 - f5.0 - .235ET - Unmounted
110116	81140305	Lens D1.5 - f5.0 - .300ET - Unmounted
110117	81140306	Lens D1.5 - f5.0 - .300ET - Mounted
110125	81140307	Lens D2.0 - f5.0 - .380ET - Unmounted
110186	81140400	Lens D1.5 - f7.5 - .300ET - Mounted
110127	81140186	Lens D2.0 - f7.5 - .300ET - Mounted
<b>Bystronic</b>		
110111	4-00186	Lens D1.5 - f5.0 - .236ET - Meniscus
110112	4-00187	Lens D1.5 - f7.5 - .236ET - Meniscus
110113	4-05094	Lens D1.5 - f5.0 - .350ET - Meniscus
110114	4-05095	Lens D1.5 - f7.5 - .350ET - Meniscus
<b>Cincinnati</b>		
110092	908085	Lens D1.5 - WD5.13 - .280ET
110096	909484	Lens D1.5 - WD7.63 - .300ET
<b>Mazak</b>		
110116	Z50ZZ000400	Lens D1.5 - f5.0 - .300ET
110123	Z50ZZ005160A	Lens D2.0 - f5.0 - .380ET
110106	Z50ZZ005200	Lens D2.0 - f7.5 - .380 ET
<b>Mitsubishi</b>		
110144	W500	Lens D1.5 - f5.0 - .300ET
110169	W505	Lens D2.0 - f5.0 - .310ET
110122	W510	Lens D2.0 - f7.5 - .310ET
<b>Trumpf</b>		
110109	088114	Lens D1.5 - f5.0 - .291ET - Meniscus
110110	097517	Lens D1.5 - f7.5 - .291ET - Meniscus

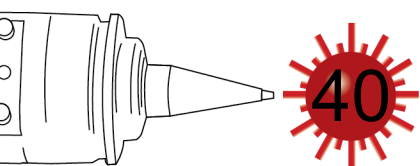

Contact Us

sales@a-l-e.net  
P:248 449 3714  
F:248 449 7631  
www.a-l-e.net



Standard Focusing Lenses and Optics

Standard Optics Care Kit

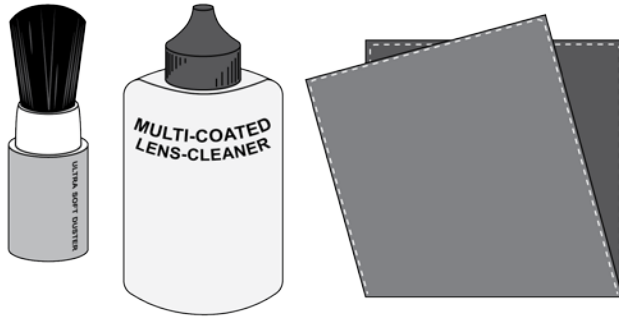

Part No.	210024
OEM / Reference No.	N/A
<b>Optics Care Kit</b>	

Part No.	210011
OEM / Reference No.	N/A
<b>Premium Grade Optics Tissue (25)</b>	

**Kit Includes**

- 1. Multi-Coated Lens Cleaner 1 fl. oz.
- 1. Ultra-soft duster
- 1. Lens Cleaning Soft Cloth
- 3. Premium Grade Optical Tissue (25)
- 1. Care Kit carrying case





**CABLES**  
**Custom Shielded**  
**and OEM Replacement**

### Sensor Cable Amada



Part No.	070199
OEM / Reference No.	71341630
<b>Amada Sensor Cable 12 in.</b>	

### Sensor Cable Amada



Part No.	070200
OEM / Reference No.	71369851
<b>Amada Sensor Cable 8 in.</b>	

Part No.	070201
OEM / Reference No.	71341901
<b>Amada Sensor Cable 12 in.</b>	

### Sensor Cable Cincinnati



Part No.	070057
OEM / Reference No.	N/A
<b>Cincinnati Tip Transformer Wire 6.0 in.</b>	

have  
you found that not all  
cables are created equal?



ALE is proud to announce ArmorDillo™ Sensor Cables. We engineered this line of 100% American-made, outperforming cables to precise standards, so they can keep up with your equipment and your team.

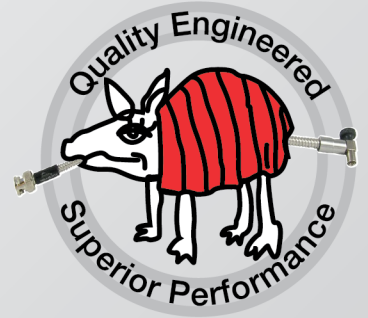

Armordillo™ cables feature:

- Additional Thermal Insulation**, which prevents burn out at the sensor nozzle connector
- Reinforced Connector Collars** to eliminate break points
- Stainless Steel Armor Sheathing** to protect against molten metal
- Custom Laser Engraving** with your logo, part number, or phone number available at no additional cost.

BNC, MCX, SMA, LTX and other specialty connectors  
Available for most major laser system height sensors including Amada®, Cincinnati®, Mazak®, Mitsubishi®, Precitec®, and Trumpf®  
Not limited to laser cables. If you need a cable call for the cables that ourperform.

American Laser Enterprises, LLC  
28221 Beck Road, Suite A-4  
Wixom, MI 48393

Phone: 248 449 3714  
Fax: 248 449 7631  
info@a-l-e.net

[www.a-l-e.net](http://www.a-l-e.net)

# We Have.



Phone: 248 449 3714 Web: www.a-l-e.net  
 Fax: 248 449 7631 E-mail: info@a-l-e.net



**ARMORDILLO™**

STRONGER.

LONGER LASTING.

ARMORED CABLES.

# Armordillo™ Cable Ordering Guide

Because of the confusion over sensor cable numbers, American Laser Enterprises has developed a selection guide to help you obtain the cables you need at the most competitive rates in the industry. **Please complete the form below and fax or E-mail your request to:**

American Laser Enterprises  
 Fax: (248) 449 7631  
 E-mail: info@a-l-e.net

Your Information	
_____ Company	
_____ Name	
_____ Address	
_____ City/State/Zip	
_____ Phone	_____ Fax
_____ E-mail	
<input type="checkbox"/> I do not want to receive special offers and communications from ALE. ALE will not share your information.	

## Build your own custom cable

1. Choose connectors. Write letter listed under desired connector in box.
2. Indicated length, units and options.
3. E-mail or Fax as listed above.

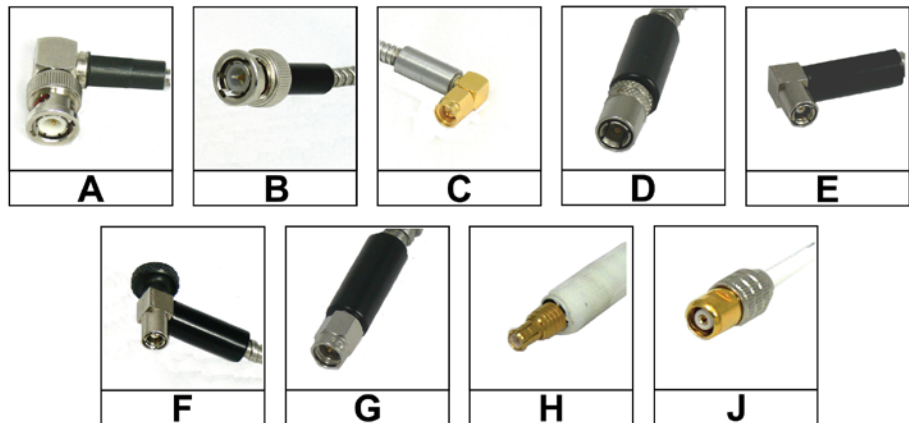

Used On:
<input type="checkbox"/> Amada
<input type="checkbox"/> Mazak
<input type="checkbox"/> Precitec
<input type="checkbox"/> _____ Other

_____ 1st Connector	_____ Length (Overall)	_____ 2nd Connector
<b>Have an OEM No.?</b> _____ It may hasten manufacturing time.	<b>Units</b> <input type="checkbox"/> English <input type="checkbox"/> Metric	<b>Option</b> <input type="checkbox"/> No Armor



### Sensor Cable Cincinnati

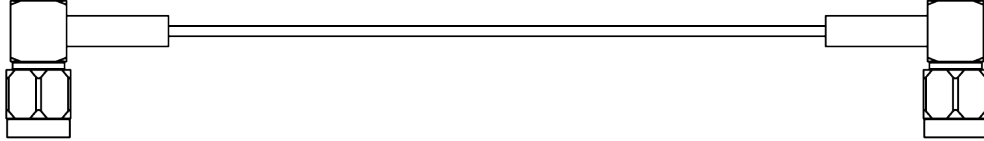

Part No.	070051
OEM / Reference No.	909654 / 922686
<b>Cincinnati Tip Transformer Wire 4.5 in.</b>	

### Sensor Cable Mazak



Part No.	200068
OEM / Reference No.	46683301980
<b>Mazak Sensor Cable 11 in.</b>	

Part No.	070074
OEM / Reference No.	46683301330
<b>Mazak Long Sensor Cable 12 in.</b>	

